

USR-WIFI232-D2

Embedded WiFi Module User Manual

Version: V1.0.12



Remarks: This module is applicable to USR-WIFI232-D2. For Other modules please refer to the corresponding document.

Note: this article is based on the firmware version for V5.01.01 and above version of the module, if the version is lower than this version, some function is not supported.

Table Of Contents

1 Quick Start.....	7
1.1 Hardware connect.....	7
1.2 Network connection.....	8
1.3 Communication test.....	9
2 Product Overview.....	9
2.1 General Description.....	10
2.2 Device Features.....	10
2.3 Device Parameters.....	11
2.4 Key Application.....	12
2.5 Package Information.....	12
2.5.1 Recommended Reflow Profile.....	12
2.5.2 Device Handling Instruction (Module IC SMT Preparation).....	12
2.5.3 Shipping Information.....	13
3 Hardware Introduction.....	13
3.1 Pins Definition.....	13
3.1.1 USR-WIFI232-D2 Pins Definition.....	13
3.1.2 USR-WIFI232-D2 Size.....	15
3.2 Antenna.....	15
3.2.1 On-board Chip Antenna.....	15
3.2.2 External Antenna.....	16
3.3 Evaluation Kit.....	17
3.4 Hardware Reference Design.....	18
3.4.1 Hardware Typical Application.....	18
3.4.2 10/100M Ethernet Interface.....	19
3.4.3 UART Interface.....	19
3.4.4 Power Interface.....	20
4 Modules Function Description.....	20
4.1 User configuration process.....	20
4.2 Working mode.....	21
4.2.1 Transparent Transmission Mode.....	21
4.2.2 Serial command mode.....	21
4.2.3 GPIO mode.....	23
4.2.4 HTTPD Client mode.....	23
4.2.5 Modbus TCP <=> Modbus RTU mode.....	24
4.3 Wireless Networking.....	24
4.3.1 STA.....	25
4.3.2 AP.....	25
4.3.3 AP+STA.....	26
4.4 Ethernet Interface Communication.....	27
4.4.1 USR-WIFI232-D2 Ethernet Interface Networking (As AP).....	27
4.4.2 USR-WIFI232-D2 Ethernet Interface Networking (As STA, N-Ver).....	28

4.4.3 USR-WIFI232-D2 Ethernet Interface Networking (As STA, Z-Ver).....	28
4.5 WI-FI parameter setting.....	29
4.5.1 Auto- Frequency Function.....	29
4.5.2 Security.....	29
4.5.3 Search Function for STA.....	29
4.5.4 Address Binding.....	30
4.6 UART Frame Scheme.....	30
4.6.1 UART Free-Frame.....	30
4.6.2 UART Auto-Frame.....	30
4.7 Network Setting.....	31
4.7.1 Socket A.....	31
4.7.2 Socket B.....	31
4.8 New function.....	31
4.8.1 TCP password authentication.....	31
4.8.2 Upload ID.....	32
4.8.3 Self-adaption Baudrate.....	32
4.8.4 WEB IO.....	32
4.8.5 Keepalive.....	32
4.8.6 Multiple STA parameters.....	33
4.8.7 Websocket.....	33
4.8.8 Fast access Wi-Fi(usrlink).....	33
4.8.9 Software flow control.....	35
4.8.10 Domain backup and Smart Station.....	35
4.9 Palmodic Signal.....	35
4.10 Parameters Configuration.....	36
4.11 Firmware Upgrade.....	36
5 Web Accessing and AT+instruction set.....	37
5.1 Configuration via Web Accessing.....	37
5.1.1 Open Web Management Interface.....	37
5.1.2 Quick Configure.....	38
5.1.3 Mode Selection Page.....	38
5.1.4 AP Interface Setting Page.....	39
5.1.5 STA Interface Setting Page.....	39
5.1.6 Application Setting Page.....	40
5.1.7 Ethernet Setting.....	41
5.1.8 HTTPD Client Mode.....	42
5.1.9 WEB IO.....	42
5.1.10 Advanced Page.....	43
5.1.11 Device Management Page.....	43
5.2 AT+instruction Introduction.....	44
5.2.1 Configuration Mode.....	44
5.2.1.1 Switch to Configuration Mode.....	45
5.2.2 AT+ Instruction Set Overview.....	45
5.2.2.1 Instruction Syntax Format.....	47

5.2.2.2 AT+ Instruction Set.....	48
5.2.2.2.1 AT+E.....	50
5.2.2.2.2 AT+ENTM.....	50
5.2.2.2.3 AT+NETP.....	50
5.2.2.2.4 AT+UART.....	51
5.2.2.2.5 AT+UARTF.....	51
5.2.2.2.6 AT+UARTFT.....	52
5.2.2.2.7 AT+UARTFL.....	52
5.2.2.2.8 AT+TMODE.....	52
5.2.2.2.9 AT+WMODE.....	52
5.2.2.2.10 AT+WSKEY.....	53
5.2.2.2.11 AT+WSSSID.....	53
5.2.2.2.12 AT+ WSLK.....	54
5.2.2.2.13 AT+WEBU.....	54
5.2.2.2.14 AT+WAP.....	54
5.2.2.2.15 AT+WKEY.....	55
5.2.2.2.16 AT+HIDESSID.....	55
5.2.2.2.17 AT+MSLP.....	56
5.2.2.2.18 AT+WSCAN.....	56
5.2.2.2.19 AT+ TCPLK.....	56
5.2.2.2.20 AT + TCPDIS.....	57
5.2.2.2.21 AT+ WANN.....	57
5.2.2.2.22 AT+ LANN.....	57
5.2.2.2.23 AT+DHCPDEN.....	58
5.2.2.2.24 AT+ DHCPGW.....	58
5.2.2.2.25 AT+ TCPTO.....	58
5.2.2.2.26 AT+ MAXSK.....	59
5.2.2.2.27 AT+TCPB.....	59
5.2.2.2.28 AT+TCPPTB.....	59
5.2.2.2.29 AT+TCPADDB.....	60
5.2.2.2.30 AT+TCPTOB.....	60
5.2.2.2.31 AT+TCPLKB.....	60
5.2.2.2.32 AT+STTC.....	60
5.2.2.2.33 AT+DOMAIN.....	61
5.2.2.2.34 AT+FUDLX.....	61
5.2.2.2.35 AT+MMID.....	61
5.2.2.2.36 AT+IDFIR.....	62
5.2.2.2.37 AT+IDEVE.....	62
5.2.2.2.38 AT+AABR.....	62
5.2.2.2.39 AT+RELD.....	63
5.2.2.2.40 AT+Z.....	63
5.2.2.2.41 AT+MID.....	63
5.2.2.2.42 AT+VER.....	63
5.2.2.2.43 AT+H.....	63

5.2.2.2.44 AT+ HTTPURL.....	63
5.2.2.2.45 AT+ HTTPTP.....	64
5.2.2.2.46 AT+ HTTPPH.....	64
5.2.2.2.47 AT+ HTTPCN.....	64
5.2.2.2.48 AT+ HTTPUA.....	64
5.2.2.2.49 AT+ EPHYA.....	65
5.2.2.2.50 AT+ EPHYB.....	65
5.2.2.2.51 AT+ WSSSIDA.....	65
5.2.2.2.52 AT+ WSSSIDB.....	65
5.2.2.2.53 AT+ WSSSIDC.....	66
5.2.2.2.54 AT+ WSKEYA.....	66
5.2.2.2.55 AT+ WSKEYB.....	67
5.2.2.2.56 AT+ WSKEYC.....	67
5.2.2.2.57 AT+ WSQY.....	68
5.2.2.2.58 AT+ HTPMODE.....	68
5.2.2.2.59 AT+ HTPSV.....	68
5.2.2.2.60 AT+ HTPTP.....	69
5.2.2.2.61 AT+ HTPURL.....	69
5.2.2.2.62 AT+ HTPHEAD.....	69
5.2.2.2.63 AT+ REGEN.....	70
5.2.2.2.64 AT+ REGTCP.....	70
5.2.2.2.65 AT+ REGID.....	70
5.2.2.2.66 AT+ IPBUP.....	70
5.2.2.2.67 AT+ STAPRO.....	71
6 USR-WIFI232-D2 Usage Introduction.....	71
6.1 Module Debug.....	71
6.1.1 Software Debug Tools.....	71
6.1.2 Network Connection.....	71
6.1.3 Debug.....	72
6.2 Use Cases.....	74
6.2.1 Wireless Control Application.....	74
6.2.2 Remote Management Application.....	75
6.2.3 Transparent Serial Port Application.....	75
6.2.4 Wireless Data Acquisition Card Application.....	76
Appendix A: Questions and Answers.....	78
Q1: How to configure transparent serial port application (TCP protocol) with two WIFI modules?.....	78
Q2: Where to Set WIFI Module LAN IP and WAN IP through Web Page?	79
Q3: How to configure transparent serial port application (UDP protocol) with two WIFI modules?.....	79
Q4: Where to set USR-WIFI232-D2 module network protocol (TCP/UDP)?.....	80
Q5: How to configure transparent serial port application: Two WIFI modules all configured as STA and connection through AP?.....	81
Q6: How to avoid IP address confliction when apply USR-WIFI232-D2 module?.....	82

Q7: PC works as server, all WIFI modules work as data acquisition card and connect with PC, how to configure this application?.....	82
Q8: WIFI module support UDP multicast?.....	83
Q9: WIFI module operates in STA mode, the PC how to get the IP module?.....	84
Appendix b: evb reference design.....	85
Appendix c: external power shutdown mode reference design.....	86
Appendix e: Contact Information.....	87
Appendix f: Disclaimer.....	87
Appendix g: History.....	88

1 Quick Start

USR-WIFI232-D2 series product is used to transmit data between RS232 and WIFI or Ethernet TCP/IP transparently, user can update the product to WIFI or Ethernet interface control without knowing the WIFI ,Ethernet and TCP/IP detail. All the convert work is done by the module. For users, the RS232 side is only as a serial device,the WIFI side or Ethernet is TCP/IP Socket data. User can setup the work detail by sample settings which can setup via inside web pages or RS232 port. The setup work only need do once, then it will save the setting forever.

This chapter is a user guide for USR-WIFI232-D2 series products. We suggest users follow the guide to test module at first, and will have a good understanding of the modules. Users can also choose the chapter which you are interested in to read. For specific details and instructions, please refer to the following chapters.

If there are problems in using the process, you can refer to the official website of our application case:

<http://www.usriot.com/Faq/cat-47.html>

We can also submit the issue to our customer support center:

<http://h.usriot.com>

1.1 Hardware connect

In order to test this module, we need connect module RS232 to PC and also WIFI or Ethernet to PC.

In order to test the communication between serial and WIFI or Ethernet network, we need to connect the serial port to PC, and also connect WIFI or Ethernet networks to PC.

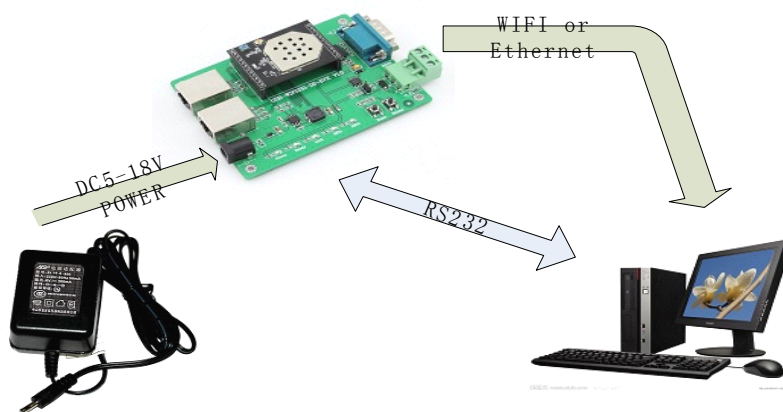

Figure 1 **hardware connection diagram**

About the serial connection, because the module RS232 is 3.3V TTL level, the computer can not connect to module directly, the user needs to have a TTL to RS232 adapter cable and then

connect to the computer. in order to facilitate the test, we provide USR-WIFI232-D2-EVK evaluation board for users to choose.

1.2 Network connection

Open Wi-Fi, search network on the PC, as shown in below, USR-WIFI232-D2_3378 is the default network name (SSID) of the module.

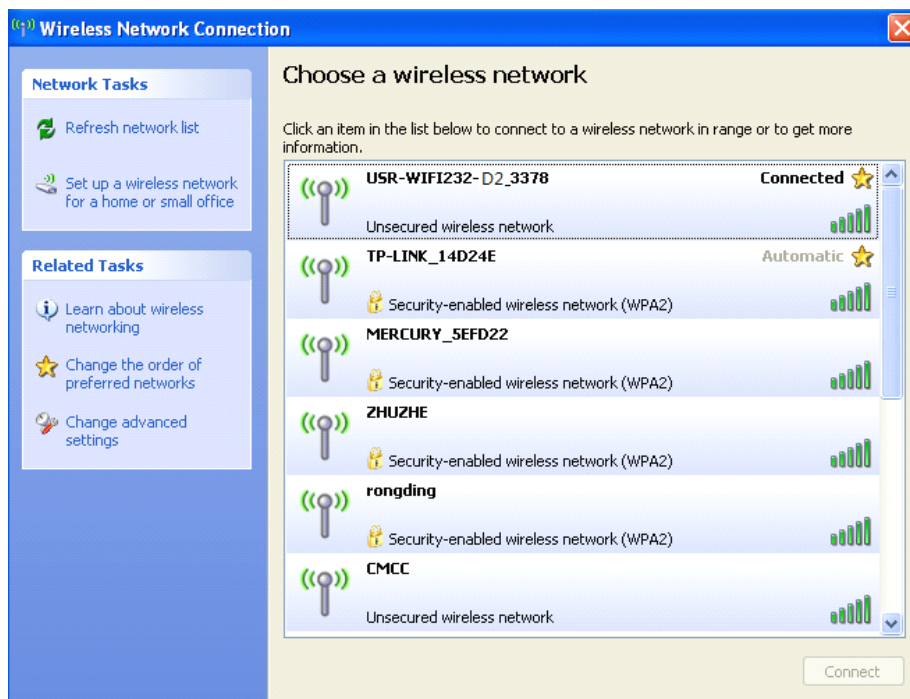

Figure 2 **WIFI Search**

Join the network, choose to automatically obtain IP, USR-WIFI232-D2 module supports DHCP Server feature and is enabled by default.

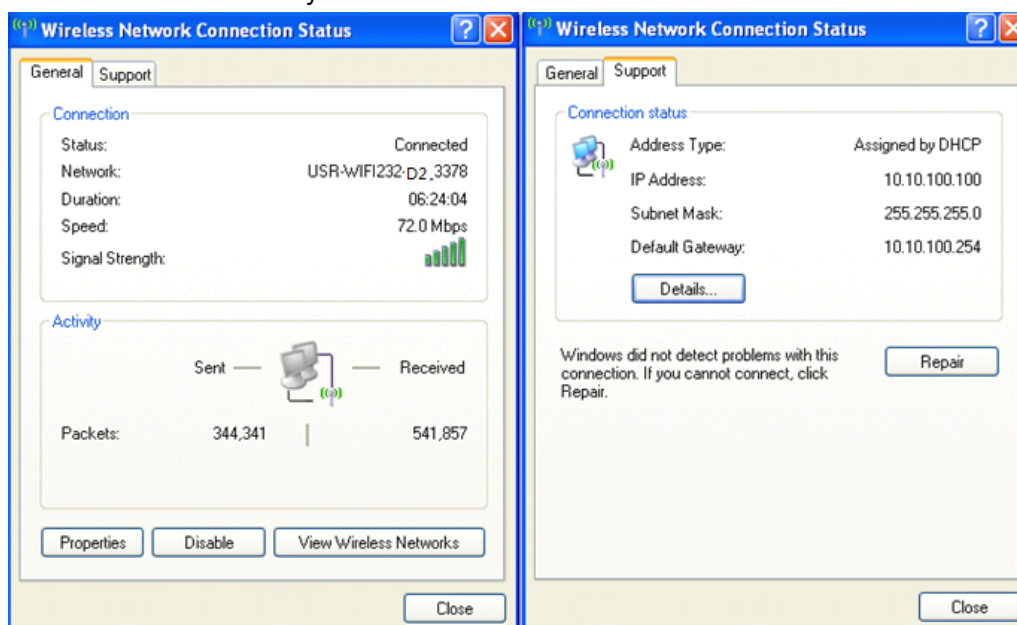

Figure 3 **WIFI connection**

Now, link led of USR-WIFI232-D2-EVK Evaluation Board is lighting.

1.3 Communication test

Module' s default setting:

- **SSID:**USR-WIFI232-D2_XXXX(XXXX is the last of mac address);
- **Encryption mode:**open, none;
- **UART:**57600,8,1,None;
- **Network parameters:** TCP,Server,8899,10.10.100.254;
- **IP:**10.10.100.254;

We just need to follow the parameters of the corresponding set of network communication parameters, you can make serial <--> WIFI or Ethernet communication, the steps are as follows:

1. Open test software USR-TCP232-Test;
2. COM Settings area (left):

Choose COM port which has connect the module, there is COM3, choose baud rate to 57600, this is the default baud rate of WIFI module, Click Open COM port.

3. Net Settings area (right):

Choose TCP client mode, Server IP write 10.10.100.254, it is the WIFI default IP address, Server port to 8899, It is the default Port the WIFI module listen, Click Connect to link to the module.

Now, you can test send data between RS232 and WIFI.

COM port to WIFI: PC RS232 -> Module RS232 -> Module WIFI -> PC WIFI.

WIFI to COM port: PC WIFI or Ethernet -> Module WIFI or Ethernet -> Module RS232 -> PC RS232.

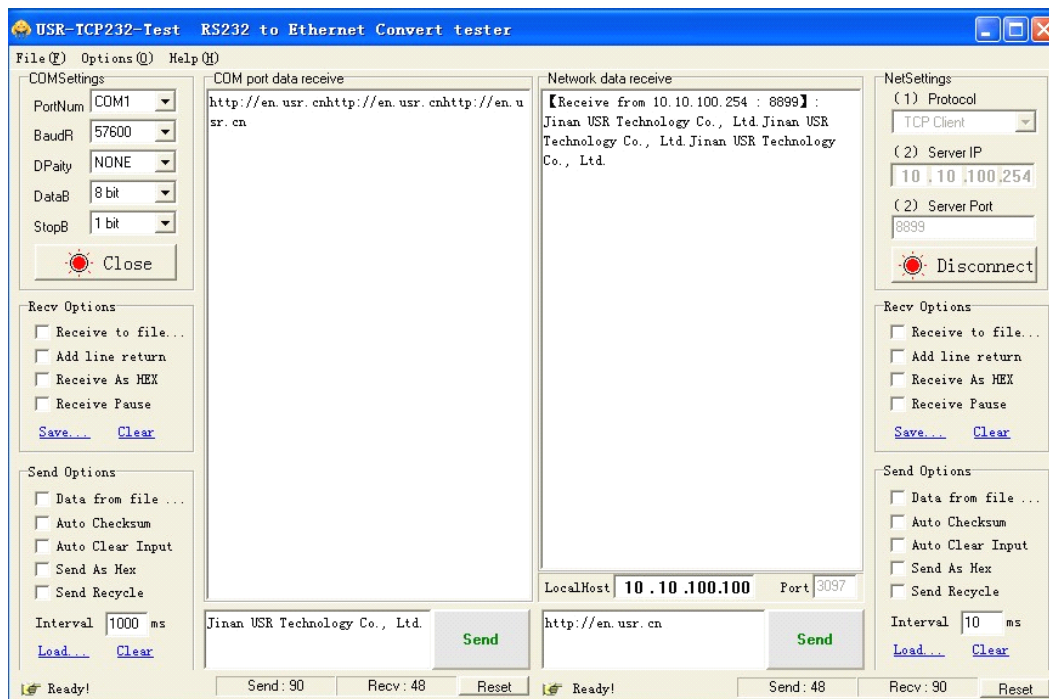

Figure 4 serial / network transmission test

2 Product Overview

2.1 General Description

USR-WIFI232-D2 module is an integration of 802.11 b/g/n wi-fi module, which provide a wireless interface and a Ethernet interface to any equipment with a Serial interface for data transfer.

The module used to MAC, Ethernet interface, baseband chip, RF transceiver unit, as well as the power amplifier; Embedded firmware support wi-fi protocols and configuration, as well as the network TCP/IP protocol stack.

USR-WIFI232-D2 uses the industry's highest performance embedded industrial structure, and for the application of smart furniture, smart grid, handheld devices, personal medical, industrial control, etc. These data fields, do a professional optimization.

USR-WIFI232-D2 as a hotspot can accommodate 32 clients simultaneously wi-fi access, but also can accommodate 32 TCP client.

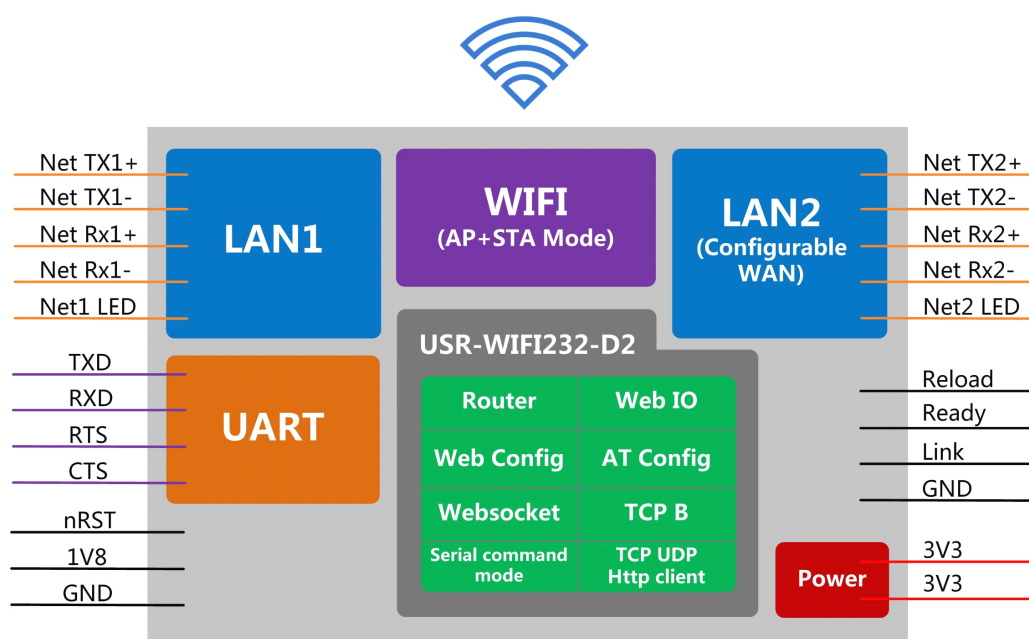

Figure 5 **Block diagram**

2.2 Device Features

- ✦ **Support IEEE802.11b/g/n Wireless Standards**
- ✦ **Support TCP/IP/UDP Network Protocols**
- ✦ **Support UART/GPIO/Ethernet Data Interface**
- ✦ **Support Work As STA/AP/AP+STA Mode**
- ✦ **Support Router/Bridge Mode Networking**
- ✦ **Support Internal/External Antenna Option**
- ✦ **Support Transparent Transmission Mode**

- ✧ **Support AT+ Instruction Set for Configuration**
- ✧ **Support Friendly Web Configuration Page**
- ✧ **Support Palmodic Signal**
- ✧ **Support UART Auto-Frame Function**
- ✧ **Single +3.3V Power Supply**
- ✧ **Small Size: 45*32mm**
- ✧ **FCC/CE Certificated**

2.3 Device Parameters

Table 1 **USR-WIFI232-D2 Module Technical Specifications**

Class	Item	Parameters
Wireless Parameters	Certification	FCC/CE
	Wireless standard	802.11 b/g/n
	Frequency range	2.412GHz-2.484GHz
	Transmit Power	802.11b: +20 dBm (Max.)
		802.11g: +18 dBm (Max.)
		802.11n: +15 dBm (Max.)
		Configurable
	Receiver Sensitivity	802.11b: -89 dBm
802.11g: -81dBm		
802.11n: -71dBm		
Antenna Option	External:I-PEX Connector	
	Internal:On-board chip antenna	
Hardware Parameters	Data Interface	UART: 300bps - 460800bps
		GPIOs
		Ethernet: 100Mbps
	Operating Voltage	3.3V (+/-5%)
	Operating Current	170mA~300mA
	Operating Temperature	-40°C - 85°C
	Storage Temperature	-40°C - 125°C
Dimensions and Size	45×32×8mm	
Software Parameters	Network Type	Station /AP mode/STA+AP
	Security Mechanisms	WEP/WAP-PSK/WAP2-PSK
	Encryption	WEP64/WEP128/TKIP/AES
	Work Mode	Transparent Mode/Serial command Mode
	AT command	AT+instruction set
	Network Protocol	TCP/UDP/ARP/ICMP/DHCP/DNS/HT TP
	Max. TCP Connection	32
	User Configuration	Web Server+AT command config.

2.4 Key Application

- Remote equipment monitoring
- Industrial sensors and controls
- Asset tracking and telemetry
- Home automation
- Medical devices

2.5 Package Information

2.5.1 Recommended Reflow Profile

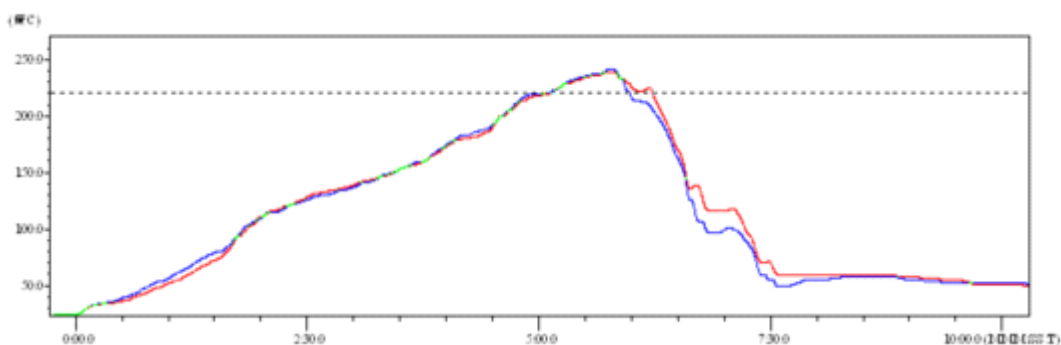

Figure 6 Reflow Soldering Profile

Table 2 Reflow Soldering Parameter

NO.	Item	Temperature (Degree)	Time(Sec)
1	Reflow Time	Time of above 220	35~55 sec
2	Peak-Temp	260 max	

Note:

1. Recommend to supply N2 for reflow oven.
2. N2 atmosphere during reflow (O2<300ppm).

2.5.2 Device Handling Instruction (Module IC SMT Preparation)

- Shelf life in sealed bag: 12 months, at <30°C and <60% relative humidity (RH)
- After bag is opened, devices that will be re-baked required after last baked with window time 168 hours.
- Recommend to oven bake with N2 supplied.
- Baked required with 24 hours at 125 ± 5 °C before rework process for two modules, one is new module and two is board with module.
- Recommend to store at ≦ 10% RH with vacuum packing.
- If SMT process needs twice reflow:
 - (1) Top side SMT and reflow à
 - (2) Bottom side SMT and reflow

Case 1: Wifi module mounted on top side. Need to bake when bottom side process over 168 hours window time, no need to bake within 168 hours.

Case 2: Wifi module mounted on bottom side, follow normal bake rule before process.

Note:

Window time means from last bake end to next reflow start that has 168 hours space.

2.5.3 Shipping Information

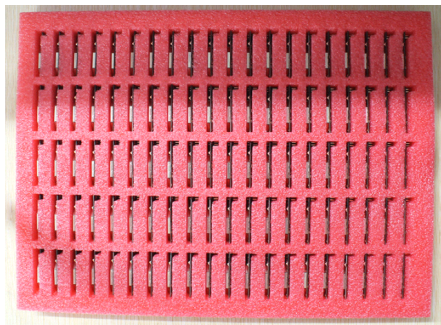

Figure 7 **Shipping Information**

TRAY Size: 420*245*34 mm

Note:

1 tray = 5*20 pcs = 100 pcs

1 box = 2 trays = 2*100 pcs = 200pcs

1 carton = 4 boxes = 4*200 pcs = 800pcs

3 Hardware Introduction

3.1 Pins Definition

3.1.1 USR-WIFI232-D2 Pins Definition

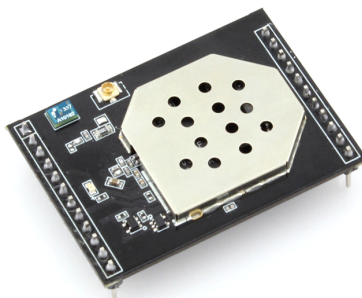

Figure 8 **USR-WIFI232-D2**

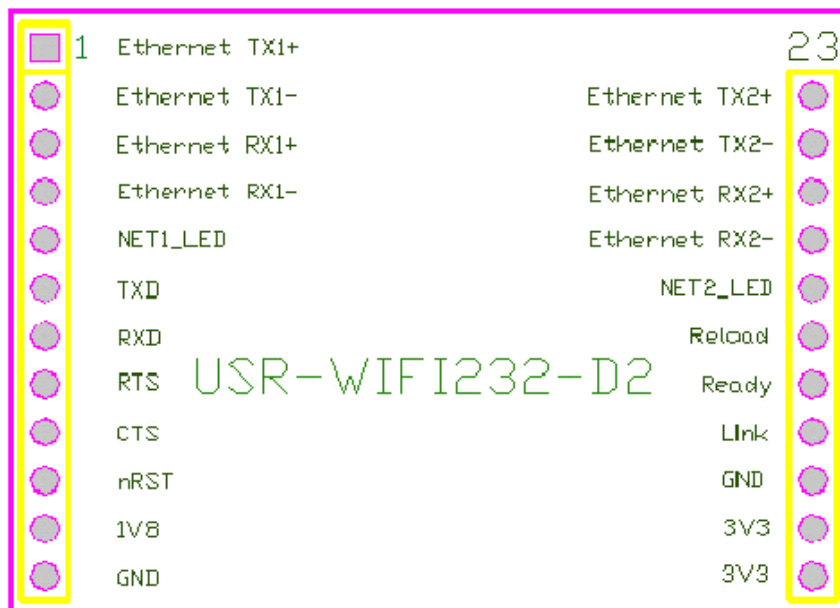

Figure 9 USR-WIFI232-D2 Pins Map

Table 3 USR-WIFI232-D2 Pins Definition

Pin	Description	Name	Direction	Note
1	Ethernet1 Output+	TX1+	O	+1.8V Ethernet Data Interface Support transformer and direct connection (AC couple) mode.
2	Ethernet1 Output-	TX1-	O	
3	Ethernet1 Input+	RX1+	I	
4	Ethernet1 Input-	RX1-	I	
5	Ethernet1 LED	NET1_LED	O	Ethernet1 pilot light
6	UART Data Transmit	UART_TXD	O	If not use UART function, this 4 pins can be configured as GPIO pins, and can change GPIO pin status through AT command.
	GPIO	GPIO3	I/O	
7	UART Data Receive	UART_RXD	I	
8	GPIO	GPIO4	I/O	
	UART sends request of data transmission	UART_RTS	O	
9	GPIO	GPIO5	I/O	
	UART receives data transmission permission	UART_CTS	I	
10	Module reset signal	nRST	I	
11	Output 1.8V	1.8V	O	1.8V@300mA, to the Eth application
12	GND	GND	Power	Ground
13/14	VCC	3.3V	Power	3.3V @ 350mA power input

15	GND	GND	Power	Ground
16	WiFi status Indication	Link	O	"0"- WiFi connection available, "1"- No WIFI connection.
17	Indicate the module status of power on process	Ready	O	"0" - Finish module boot up process; "1" - Module boot up not finish.
18	Restore configuration	Reload	I	Module will Restore factory default configuration after set this pin "0" more than 1s, then set "1".
19	Ethernet2 LED	NET2_LED	O	Ethernet2 pilot light
23	Ethernet2 Input-	RX2-	I	+1.8V Ethernet Data Interface Support transformer and direct connection (AC couple) mode.
22	Ethernet2 Input+	RX2+	I	
21	Ethernet2 Output-	TX2-	O	
20	Ethernet2 Output+	TX2+	O	

3.1.2 USR-WIFI232-D2 Size

USR-WIFI232-D2 module Mechanical Size:

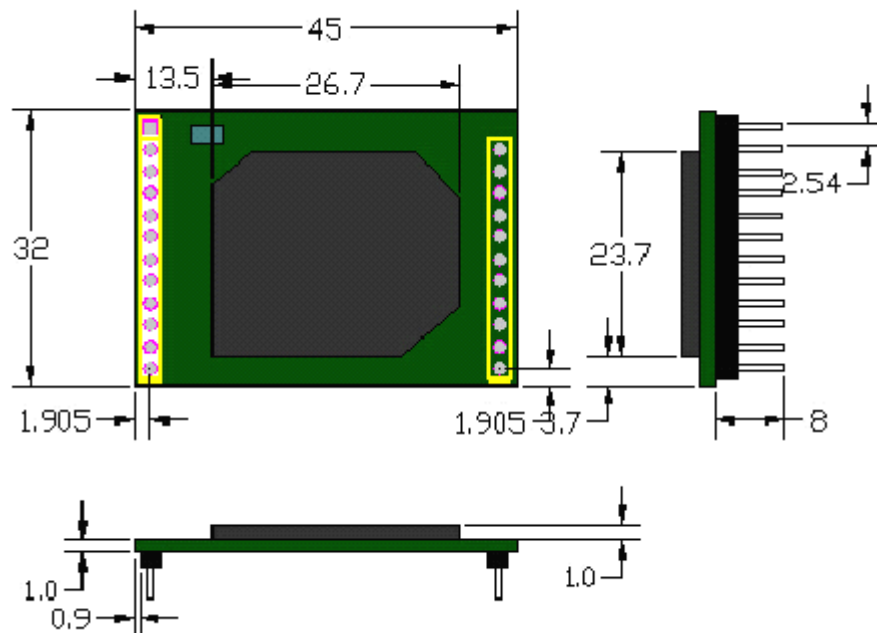

Figure 10 **USR-WIFI232-D2 Mechanical Size**

3.2 Antenna

3.2.1 On-board Chip Antenna

USR-WIFI232-D2 supports a built-in antenna options, when customers choose a built-in antenna, must comply with the following built-in antenna module placement of notes and general rules:

- Be in the user's PCB board, and the Light blue region (6X8mm) corresponding to the region cannot be placed components and with GND;
- Antenna must away from the metal, at least to the distance around the higher components above 10MM;
- Antenna cannot be shielded by any meal enclosure; All cover, include plastic, shall away from antenna at least 10MM;

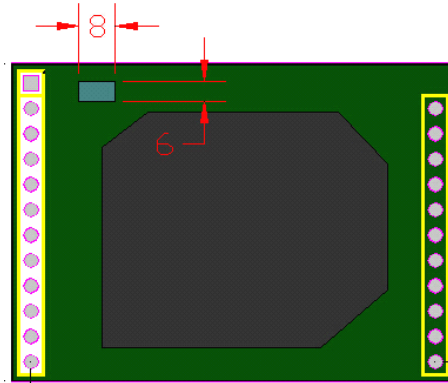

Figure 11 **USR-WIFI232-D2 Chip Antenna Keep Out Region**

USR technological suggestions USR-WIFI232-D2 module be placed in the following areas of user board, in order to reduce the antenna and a wireless signal influence, at the same time, please consult with technology and technical support staff to assist module placement and associated regions of Layout design.



Figure 12 **Suggested Module Placement Region**

3.2.2 External Antenna

USR - WIFI232 - D2 module can be done by switching the resistance external antenna interface to apply different customer application. If user select external antenna, USR-WIFI232-D2 modules must be connected to the 2.4G antenna according to IEEE 802.11b/g/n standards.

The antenna parameters required as follows:

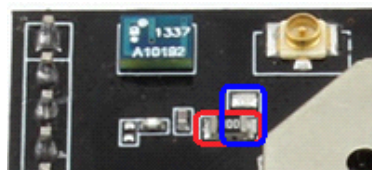

Figure 13 **Switch Resistance**

As shown in figure, switch resistance is normally in the red areas. For external antenna, the resistance change to blue area.

Table 4 **USR-WIFI232-D2 External Antenna Parameters**

Item	Parameters
Frequency range	2.4~2.5GHz
Impedance	50 Ohm
VSWR	2 (Max)
Return Loss	-10dB (Max)
Connector Type	I-PEX or populate directly

3.3 Evaluation Kit

USR provides the evaluation kit to promote user to familiar the product and develop the detailed application. The evaluation kit shown as below, user can connect to USR-WIFI232-D2 module with the RS-232 UART port, 100M Eth port or Wireless port to configure the parameters, manage the module or do the some functional tests.

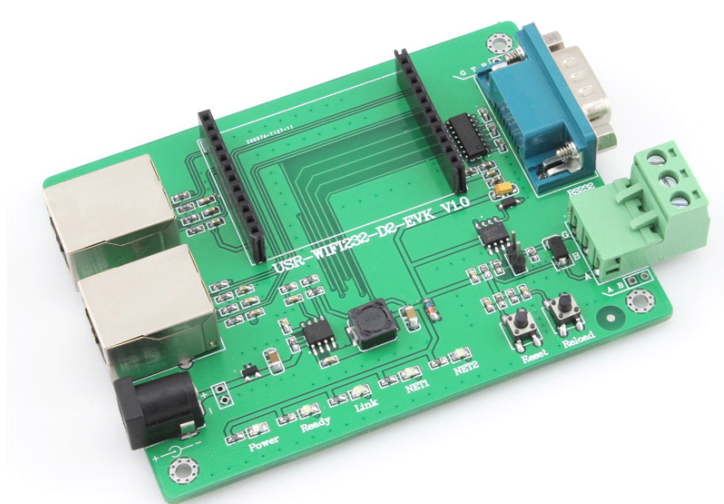

Figure 14 **USR-WIFI232-D2 module Evaluation Kit**

Table 5 **USR-WIFI232-D2 Evaluation Kit Interface Description**

Function	Name	Description
External Interface	DC jack	5V power input connector
	DB9	Male serial jack of 9-pin, and used to connect to PC
	RJ-45(1)	100M Eth Interface
	RJ-45(2)	100M Eth Interface
	Module	2x12 2.54mm DIP connector, connect WIFI module
LED	Power (Red)	3.3V Power Indicator
	NET1	Ethernet1 LED
	NET2	Ethernet2 LED
	Ready	Ready/GPIO Indicator
	Link	Link/GPIO Indicator
Button	Reset	Used to reset the module.
	Reload	Module restore to factory default configuration.

3.4 Hardware Reference Design

3.4.1 Hardware Typical Application

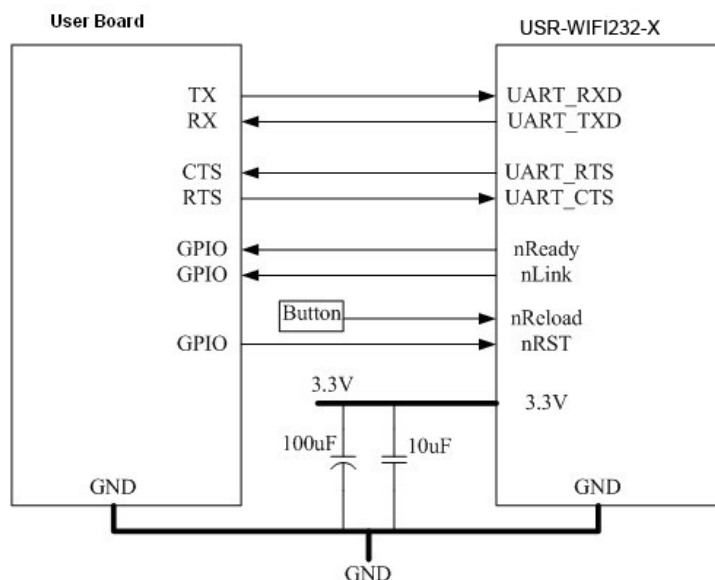

Figure 15 **USR-WIFI232-D2 Hardware Typical Application**

Notes:

nRST- Module hardware reset signal. Input. Logics "0" effective.

There is 100K Ohm pull-up resistor internal up to 3.3V. When module power up or some issue happened, MCU need assert nRST signal "0" at least 300ms, then set" 1" to keep module fully reset.

Ready- Module boot up ready signal. Output. Logics “0” effective.

There is 4.7K Ohm pull-up resistor internal up to 3.3V. The module will output “0” or “Palmodic Signal” after normal boot up. This signal used to judge if module finish boot up and ready for application or working at normal mode.

Link- Module WIFI connection indication. Output.

There is 4.7K Ohm pull-up resistor internal up to 3.3V. When module connect to AP (STA mode) or some WiFi STA connect to module (AP mode), the module will output “0”. This signal used to judge if module already at WiFi connection status.

nReload- Module restore to factory default configuration.Input. Logics “0” effective.

User can assert nReload signal “0” more than 3’s through button or MCU pin, then release, module will restore to factory default configuration and re-start boot up process. User need add 4.7K~10K Ohm pull-up resistor external the module.

UART_TXD/RXD- UART port data transmit and receive signal.

There is 1K Ohm pull-down resistor internal. User can’t add pull-up resistor at these pins.

3.4.2 10/100M Ethernet Interface

User board put Ethernet transformer and RJ-45 connector. This is a general 10/100M Ethernet phy layer connection. The reference design as following:

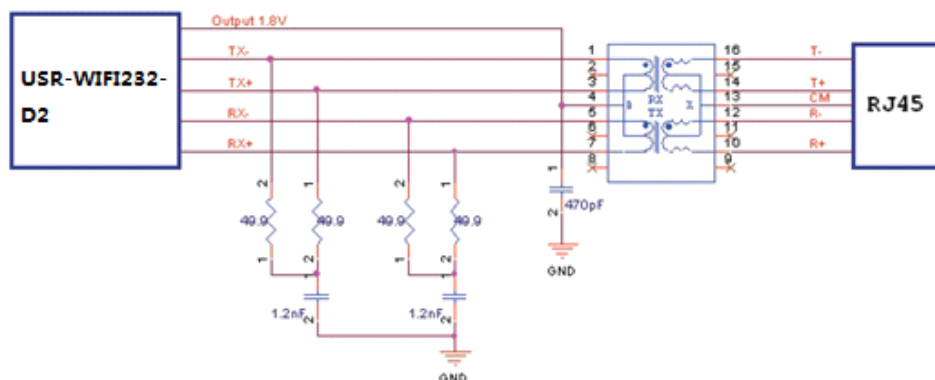

Figure 16 **Ethernet Reference Design with Transformer**

3.4.3 UART Interface

UART interface is the serial data transmission interface mainly used for USR-WIFI232-D2 modules. User can add RS-232 chipset on user board and convert the signal to RS-232 voltage to communicate with outside equipment or sensors. USR-WIFI232-D2 modules UART interface include 4 general signals: TXD/RXD/RTS/CTS. The hardware reference design with RS-232 chipset as following:

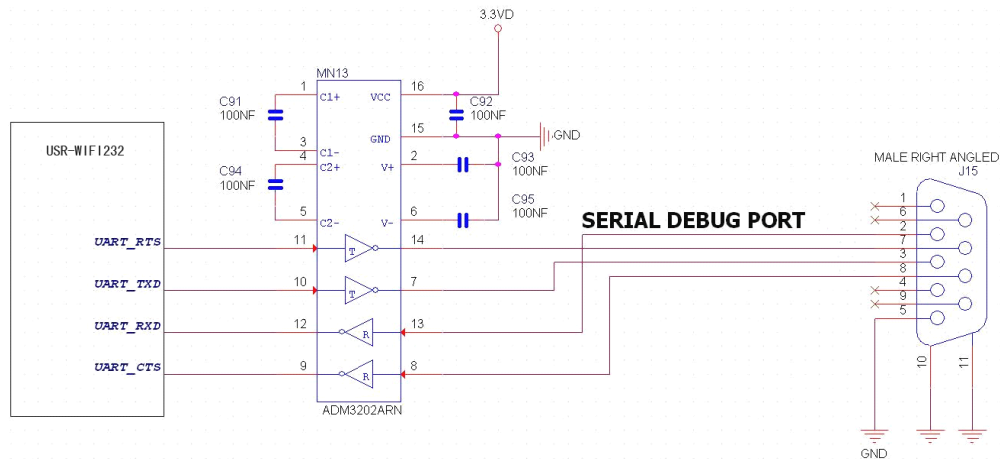

Figure 17 **Figure 10 UART Interface Reference Design**

Notes: TXD pin is also hardware configuration pin internal module. So this pin MUST pull-down during module power up. USR-WIFI232-D2 modules provide internal pull-down resistor, user can't add pull-up/pull-down resistor on user board, which may cause module can't work.

3.4.4 Power Interface

USR-WIFI232-D2 module support single +3.3V power supply. The peak current shall about 350mA and normal WiFi working current shall about 200mA. The power save (WiFi OFF) mode will about 100mA

Decoupling at power pin suggested, At least one 100uF, one 10uF and one 100nF capacitor required at user board and put near module power input pin will increase the reliability and performance.

4 Modules Function Description

4.1 User configuration process

After USR-WIFI232-D2 module electric starter, based on user pre-set parameters, automatically connect to wireless networks and servers, and enter the working mode is set to open in accordance with the default serial port parameters.

The parameters which need to configure include:

- Wireless Network Parameters
 - ✧ Wireless Network Name (SSID)
 - ✧ Security Mode
 - ✧ Encryption Key

- TCP/UDP Linking Parameters
 - ✧ Protocol Type
 - ✧ Link Type (Server or Client)
 - ✧ Target Port ID Number
 - ✧ Target Port IP Address

 - Serial Port Parameters
 - ✧ Baud Rate
 - ✧ Data Bit
 - ✧ Parity (Check) Bit
 - ✧ Stop Bit
 - ✧ Hardware Flow Control

 - Work Mode Selection
 - ✧ Transparent transmission/Serial command mode/GPIO mode/HTTPD Client mode
- The following sections will introduce specific to each part in detail.

4.2 Working mode

4.2.1 Transparent Transmission Mode

USR-WIFI232-D2 modules support serial interface transparent transmission mode. The benefit of this mode is achieves a plug and play serial data port, and reduces user complexity furthest. In this mode, user should only configure the necessary parameters. After power on, module can automatically connect to the default wireless network and server.

As in this mode, the module's serial port always work in the transparent transmission mode, so users only need to think of it as a virtual serial cable, and send and receive data as using a simple serial. In other words, the serial cable of users' original serial devices is directly replaced with the module; user devices can be easy for wireless data transmission without any changes.

The transparent transmission mode can fully compatible with user's original software platform and reduce the software development effort for integrate wireless data transmission.

Notes: Users also open the serial port hardware flow control (CTS/RTS) function, so that we can make the bit error rate to a minimum.If the user doesn't need hardware flow control function of the serial port, only need to the corresponding pin foot (CTS/RTS) hung up.

4.2.2 Serial command mode

In this mode, the user can send the serial data to a different server address, this pattern can be use UDP or TCP client sends data to the server.

Customer MCU send packets according to the following format, parsing module is finished, only the n bytes of data sent to the destination address.When data is returned, not analytical data from serial port output directly.

Table 6 **Protocol table of Serial command mode**

frame header	length	function byte	Backup data area	Destination port	Target address	Data	Sum check
2	2 (n+m+5)	1	2	2	m	n	1

frame header:

0x55 0xAA (Constant)

Length:

Starting from the function byte, to Sum check (does not contain the sum check) all bytes.

High byte at the front
Function byte:

Bit0: (UDP:0 ;TCP:1)

Bit1: (Short connection:0;Long connection:1)

Bit2: (IP:0;Domain name:1)

Bit7: (cut protocol:0;full protocol:1) **Note: currently only supports cut protocol**

Notes:

- ✧ Bit1:If it is a short connection, it sends data, and then will be disconnected; if it is long connection, it sends data, connection will remain, until the re changing the target address.
- ✧ Bit2:Indicates that the target address is IP or domain name. If it is IP, the target address is 4 bytes; if the domain name, the target address length for the entire domain name string length (the last byte address is '\0', that is the end of the string).
- ✧ Bit7:Under the cut protocol, reply frame contains only data; Under the full protocol, reply frame has "failed to send", "waiting for", "UDP radio response equipment IP" frame data.

Backup data area:

- ✧ First byte:If it is a short connection, this position is TCP waits for the timeout time (1-255), if the send command is completed, did not receive a response, then wait a few seconds and the corresponding, if 5, said to wait for the 5S to disconnect; if the sending command, immediately receive the returned data, then immediately disconnected; if it is long connection, this position is 0x00.
- ✧ Second byte:Reserve

Destination port:

Little endian, low byte in the former,such as port 23, here are 0x17 0x00

Target address:

If it is IP, is 4 bytes, for example, 192.168.0.7 said 0x07 0x00 0xA8 0xC0; if it is a domain name, then the address of indefinite length,ending with the'\0'.

Data:

Variable length,the maximum not exceeding 1000bytes.

Sum check:

From the function word to check byte (does not contain a check byte), add Sum check.

The following is an example of a specific application:

send data:0x55 0xaa 0x00 0x0a 0x00 0x00 0x00 0x21 0x00 0x85 0x00 0xA8 0xC0 0x01 0x0f

Length:0x00 0x0a

Function byte:0x00 (UDP;Short connection;IP;cut protocol)

Destination port:0x21 0x00(33)

Target address:0x85 0x00 0xA8 0xC0 (192.168.0.133)

Data:0x01(data length :1)

Sum check:0x0f (0x00+0x00+0x00+0x21+0x00+0x85+0x00+0xA8+0xC0+0x01=0x0f)

4.2.3 GPIO mode

USR-WIFI232-D2 module support GPIO mode,At GPIO,UART (TXD/ RXD/CTS/RTS) defined as GPIO and others (Ready/Link/) also defined as GPIO pin.

When module works at GPIO mode, PC and other equipments can setup connection (TCP/UDP) through WiFi, then read/write GPIO information through command.

- ✧ GPIO n IN, Set GPIO n as input, Response GPIO OK or GPIO NOK;
- ✧ GPIO n OUT 0, Set GPIO n as output and output '0', Response GPIO OK or GPIO NOK;
- ✧ GPIO n OUT 1, Set GPIO n as output and output '1', Response GPIO OK or GPIO NOK;
- ✧ GPIO n SW, Set GPIO n as output and switch the output status, Response GPIO OK or GPIO NOK;
- ✧ GPIO n PWM m1 m2, Set GPIO n output a wave: m1 is 'high' duration and m2 is 'low' duration (Time unit is 'ms' and minimal is 10ms), Response GPIO OK or GPIO NOK;
- ✧ GPIO n GET, Read GPIO n status, Response I0,I1,O0,O1, means " input low ", " input high ", " output low ", " output high "

Notes: n can be 6,7,8,9,16,17 corresponding module pin. GPIO 4 can only defined as input and GPIO 6 can only defined as output.

GPIO READ returns all current IO status, and GPIO n GET said method. Such as, I1I1I0I0I0I0O1, I said input, O output. 0 low, 1 express high.

4.2.4 HTTPD Client mode

This mode is used to send data to the HTTP server.

After setting the HTTP header format by webpage or AT command, the data sent each time by UART will add the HTTP header automatically. Convenient for the user directly submit data or read data from the HTTP server.

Below is the specific application, for example:

The first set HTTP parameters using AT instructions.

AT+HTTTPURL=192.168.1.1,80	The serveraddress and portsettings
AT+HTTTP=POST	Set the HTTP type, GET, PUT or POST
AT+HTTTPH=/set	Set the path,the mostis50 bytes
AT+HTTTPCN=keep-alive	Set the Connection,maximum length of 20bytes
AT+HTTTPUA=lwip13.2	Set the User-Agent,maximum length of 20bytes

If the sending data is 1234.In the 80 port of 192.168.1.1 will receive the following data

POST /set HTTP /1.1

Connection:keep-alive

User-Agent:lwip1.3.2

Content-Length:4

Host:192.168.1.1:80

1234

If the HTTP type is GET, the 80 port 192.168.1.1 receive data

POST /set1234 HTTP /1.1

Connection:keep-alive

User-Agent:lwip1.3.2

Content-Length:0

Host:192.168.1.1:80

Data received from server will be directly sent to the serial port,without any treatment.

Note: after V5.01D.14 version of the firmware it add a new method of HTTP header definition, called the new mode, the way at above, is called the old mode.

Users can custom HTTP headers in the way of the new mode, can add, delete, modify the contents of each HTTP header (if the HTTP request type is POST/PUT, module will automatically add the Content - Length).Including the AT + HTPMODE, AT + HTPSV, AT + HTPTP, AT + HTPURL, AT + HTPHEAD, specific instructions please refer to the AT command set process section.Similarly, also has the corresponding Settings page in the web page.

Note: in the new mode, if you use the AT command set HTTP headers, Please use the "<<CRLF>>" instead of carriage "return",in the web page,you don't need to worry about the "return".

4.2.5 Modbus TCP <=> Modbus RTU mode

This feature is based on V5.01.18 or above.

This module supports Modbus TCP to Modbus RTU (does not support MODBUS ASCII); module of network parameters, corresponding to the network parameters of the application software, TCP server corresponding TCP client, and the port to be configured into the same, mode select Modbus RTU TCP<=>Modbus (AT commands: AT+TMODE=modbus).

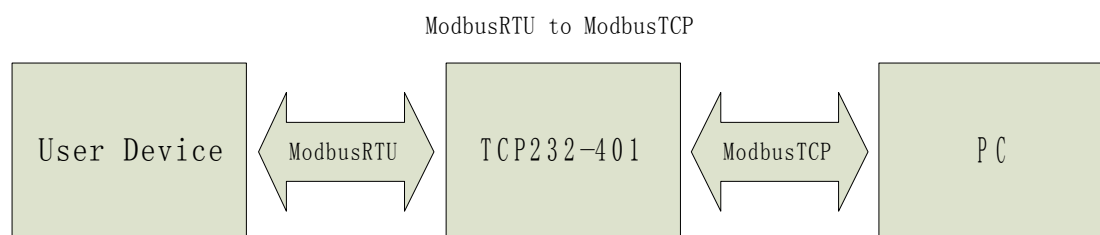

4.3 Wireless Networking

USR-WIFI232-D2 module can be configured as both wireless STA and AP base on network type. Logically there are two interfaces in USR-WIFI232-D2. One is for STA, and another is for AP. When USR-WIFI232-D2 works as AP, other STA equipments are able to connect to wireless LAN via USR-WIFI232-D2 module. Wireless Networking with USR-WIFI232-D2 is very flexible. Following figure shows the functional architecture of USR-WIFI232-D2 module:

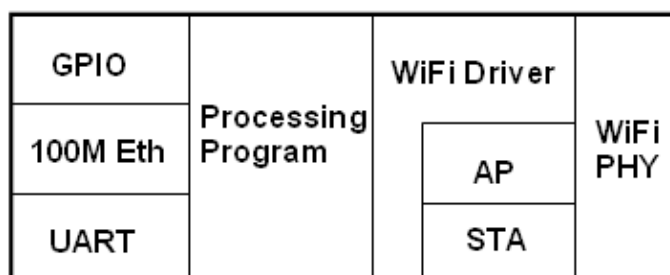

Figure 18 **USR-WIFI232-D2 Functional Architecture**

Notes:

AP: that is the wireless Access Point, the founder of a wireless network and the center of the network nodes. The wireless router we use at home or in office may be an AP.

STA: short for Station, each terminal connects to a wireless network (such as laptops, PDA and other networking devices) can be called with a STA device.

4.3.1 STA

Infrastructure: it's also called basic network. It built by AP and many STAs which join in.

The characters of network of this type are that AP is the center, and all communication between STAs is transmitted through the AP. The figure following shows such type of networking.

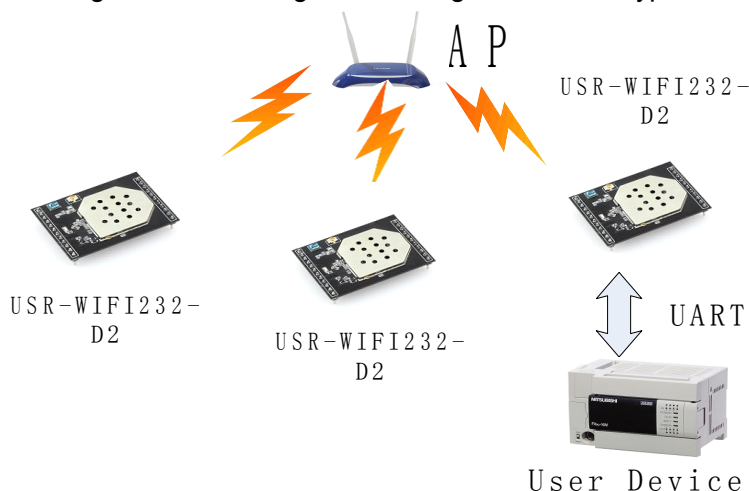

Figure 19 **USR-WIFI232-D2 Basic Wireless Network Structure**

4.3.2 AP

Because USR-WIFI232-D2 can be set to AP, can also be set to STA, so the USR-WIFI232-D2 can be achieved easily wireless ad hoc network.

As showing in the figure below, USR-WIFI232-D2 (1) can be treat as an AP, and USR-WIFI232-D2 (2), USR-WIFI232-D2 (3) and the laptop are STAs connected to USR-WIFI232-D2 (1). Meanwhile, all USR-WIFI232-D2 modules can connected to user device via UART interface. All USR-WIFI232-D2 modules can be operated and managed through the laptop. So it is convenient to O&M all USR-WIFI232-D2 modules. Moreover, in such Adhoc network structure, the whole coverage of a wireless network can be extended easily.

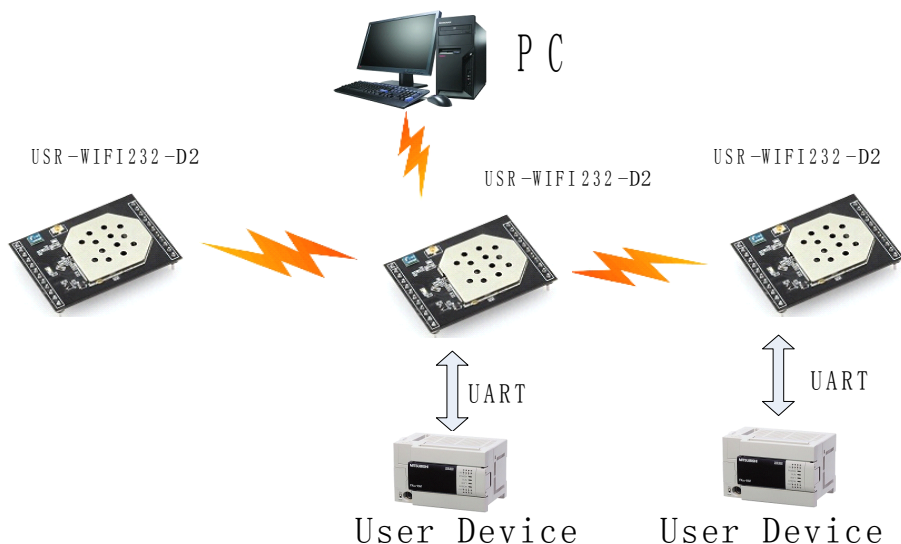

Figure 20 **USR-WIFI232-D2 STA Network Structure**

4.3.3 AP+STA

USR-WIFI232-D2 module support AP+STA network mode, means module support one AP interface and one STA interface at the same time, as following figure,

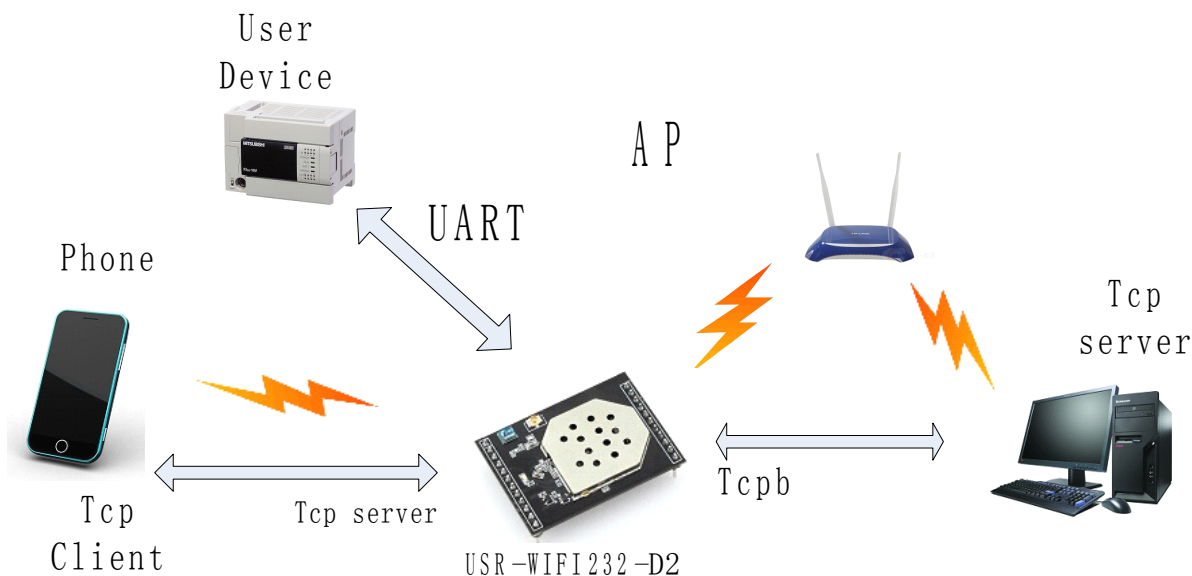

Figure 21 **USR-WIFI232-D2 AP+STA Network Structure**

When module enables AP+STA function, Module's STA interface can connect with router and connect to TCP server in the network. At the same time, module's AP interface is also active and permit phone/PAD to connect through TCPB, then phone/PAD can control user device and setting the module parameters,

The advantage of AP+STA mode is:

- Users can easily setting and track user device through Phone/PAD and not change the original network setting.

- Users can easily setting module's parameters through WiFi when module works as STA mode.

AP+STA Mode Setting:

AP+STA mode need serial AT command to enable as follows:

- AT+FAPSTA=on, Enable AP+STA mode;
- Then, when you configure module works as STA mode, it's AP interface still active;

AP+STA Mode Notes:

When user enable AT+STA function,the STA port need to keep connected with other router(AP),

or STA port will have to scan the AP frequently ,which will affect AP port function and may cause some date loss.

So ,if user confirm STA port can't connect with AP at some time,user can disable the STA scan through the following command:

- AT+STTC=on/off,on:Scan AP;off:No Scan AP.

After re-start module,this command not saved;

- AT+FSTTC=on/off;

This command is saved after re-starting the module;

4.4 Ethernet Interface Communication

USR-WIFI232-D2 module provides one 100M Ethernet interface. With this Ethernet interface, user can easily realize the three interface (WiFi, UART, and Ethernet) intercommunication and networking. USR-WIFI232-D2 module can configured as Bridge Mode or Router Mode base on different networking technology.

Notes: USR-WIFI232-630 need version switch via commands (such as following description of N-ver and Z-ver). With command AT+FVER=n to switch to N-ver and with command AT+FVER=z to switch to Z-ver.

4.4.1 USR-WIFI232-D2 Ethernet Interface Networking (As AP)

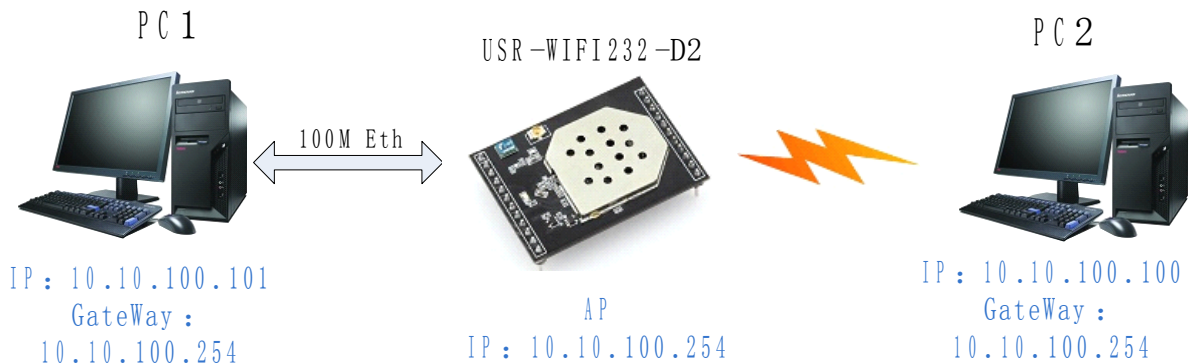

Figure 22 **USR-WIFI232-D2 Ethernet Interface Networking (As AP)**

USR-WIFI232-D2 module works as AP and also the center of this network. All devices' IP address in this network shall use the same network segment with USR-WIFI232-D2 and they can ntercommunication with this method.

4.4.2 USR-WIFI232-D2 Ethernet Interface Networking (As STA, N-Ver)

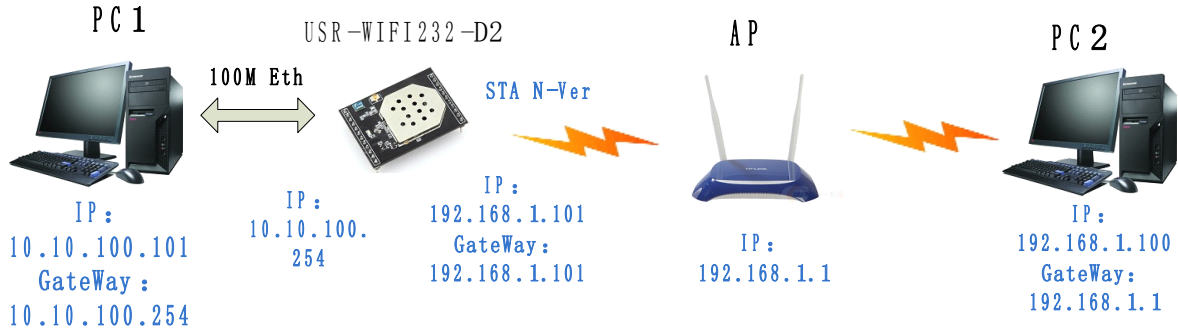

Figure 23 **USR-WIFI232-D2 Ethernet Interface Networking (As STA, N-Ver)**

USR-WIFI232-D2 module works as STA (Software is N-Version), and module set as router mode. When module connect to AP, it will get wireless port IP address from AP (For example: 192.168.1.100). At the same time, module also form a subnet (Default 10.10.100.254) and all devices connected to module Ethernet interface will get assigned IP address (For example: 10.10.100.101).So as shown, PC1 at internal subnet can initiate a connection to PC2 (For USR-WIFI232-D2 works as router mode), but PC2 can't active initiate a connection to PC1.

4.4.3 USR-WIFI232-D2 Ethernet Interface Networking (As STA, Z-Ver)

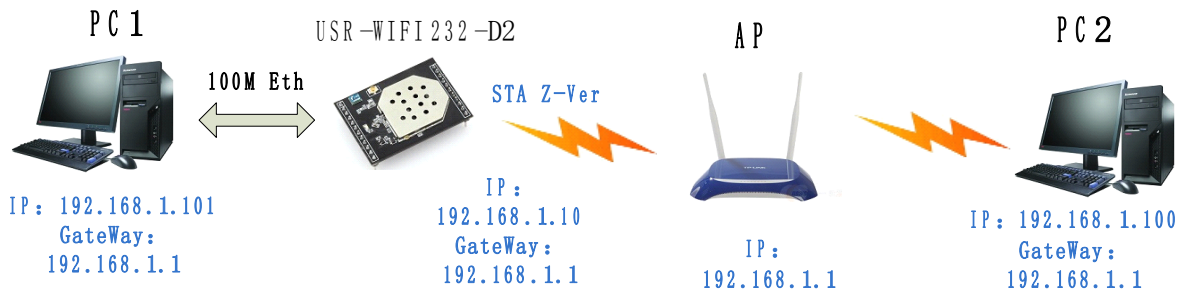

Figure 24 **USR-WIFI232-D2 Ethernet Interface Networking (As STA, Z-Ver)**

For above networking, USR-WIFI232-D2 module works as STA (Firmware is Z-Version), and module configured as bridge mode. When module connect to AP, all devices connected to module Ethernet interface will get assigned IP address from AP (For example: 192.168.1.101).For module works as bridge mode, it can be treated as a transparent device and PC1, PC2 can communicate without any limit. But in this networking, USR-WIFI232-D2 module needs assign a static LAN IP address (For example: 192.168.1.10) if module also needs communication with AP or configuration through web page.

4.5 Wi-Fi parameter setting

4.5.1 Auto- Frequency Function

When module works as STA, USR-WIFI232-D2 will adjust its wireless channel to keep the same channel with associated AP and connect in.

When module works as AP and USR-WIFI232-D2 enable Auto-frequency function, then when module boot up, it will select the best wireless channel based on surrounding environment.

4.5.2 Security

USR-WIFI232-D2 module supports multiple wireless encryption mechanisms, and enables to protect the security of user's data transmission, the mechanisms include:

- ◆ WEP
- ◆ WPA-PSK/TKIP
- ◆ WPA-PSK/AES
- ◆ WPA2-PSK/TKIP
- ◆ WPA2-PSK/AES

4.5.3 Search Function for STA

When using web configuration STA Interface Setting Page, user can push "Search" button to find surrounding AP, and find a AP to associated.

STA Interface Parameters	
AP's SSID	<input type="text" value="USR-WIFI232-AP_3378"/> <input type="button" value="Search..."/>
MAC Address (Optional)	<input type="text"/>
Security Mode	<input type="text" value="OPEN"/> ▼
Encryption Type	<input type="text" value="NONE"/> ▼

Figure 25 Search page

4.5.4 Address Binding

USR-WIFI232-D2 module supports the feature of binding the BSSID address of target network. According to the provisions of 802.11 protocol, different wireless networks can have a same network name (i.e. SSID / ESSID), but must correspond to a unique BSSID address (i.e. MAC address). Illegal intruders can create a wireless network with the same SSID / ESSID, it will make STAs in the network to join to the illegal AP, thereby and then network leakage happen.

Users can prevent STA from joining to illegal network by binding the BSSID address, to improve wireless network security.

4.6 UART Frame Scheme

4.6.1 UART Free-Frame

USR-WIFI232-D2 support UART free-frame function. If user select open this function, module will check the intervals between any two bytes when receiving UART data. If this interval time exceeds defined value (50ms default), USR-WIFI232-D2 will think it as the end of one frame and transfer this free-frame to WiFi port, or USR-WIFI232-D2 will receive UART data until 4K bytes, then transfer 4KB frame to WiFi port.

USR-WIFI232-D2's default interval time is 50ms. User can also set this interval to fast (10ms) through AT command. But user have to consider if user MCU can send UART data with 10ms interval ,or the UART data may be divide as fragment.

Through AT command: AT+FUARTTE=fast/normal, user can set the interval time: fast (10ms) and normal (50ms). This command is factory default setting command and AT+RELD can't change its value.

4.6.2 UART Auto-Frame

USR-WIFI232-D2 support UART auto-frame function. If user select open this function and setting auto-frame trigger length and auto-frame trigger time parameters, then module will auto framing the data which received from UART port and transmitting to the network as pre-defined data structure.

- **Auto-frame trigger length:** The fixed data length that module used to transmitting to the network.
- **Auto-frame trigger time:** After the trigger time, if UART port received data can't reach auto-frame trigger length, then module will transmitting available data to the network and bypass the auto-frame trigger length condition.

Detailed UART auto-frame function can refer to AT+ instruction set "UARTF/UARTFT/UARTFL" introduction.

4.7 Network Setting

USR-WIFI232-D2 module has two TCP/UDP Socket: Socket A and Socket B. Serial data written to the module, will be sent to the Socket A and B simultaneously; TCP/UDP data that module receives through either Socket A or B,will be sent to the serial port.

Dual Socket through different settings, you can achieve a variety of network interconnect. When the module shipped only open Socket A, Socket B default is not to connect, if the user needs to use, please set by AT commands.

4.7.1 Socket A

Socket A has three work mode: TCP Server, TCP Client, UDP Server,UDP Client.The setting method, please refer to the AT+NETP command instruction.

When Socket A configured as TCP Server, it supports Multi-TCP link connection, and maximum 32 TCP clients permitted to connect to Socket A.

Multi-TCP link connection will work as following structure:

Upstream: All dates from different TCP connection or client will be transmitted to the serial port as a sequence.

Downstream: All data from serial port (user) will be duplicate and broadcast to every TCP connection or client.

Detailed multi-TCP link data transmission structure as following figure:

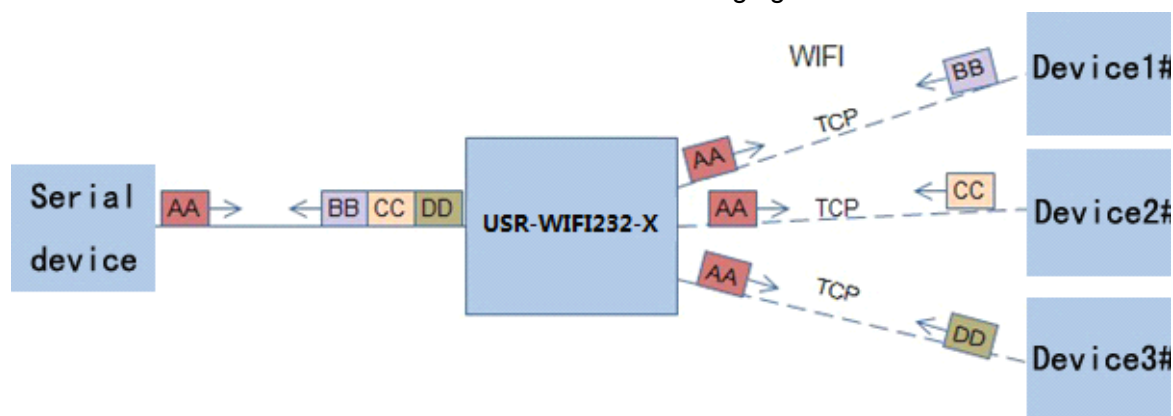

Figure 26 Multi-TCP Link Data Transmission Structure

4.7.2 Socket B

Socket B has one work mode: TCP Client, please refer to the AT + SOCKB command instruction.

With variety work mode, socket B can provide users with flexible data transfer methods. For example, Socket B can connect to a remote server in order to achieve remote control.

4.8 New function

This chapter is based on the function of V4.02.10.USR13 and above, if not this version you can skip this section.

4.8.1 TCP password authentication

This feature is available only on the module as a TCP server, when the TCP client connection module, the module will authenticate each connected tcp.

Each TCP client first data is the "password+0x0d+0x0a" (the password is Webpage authentication password). The default password is "admin", so the first piece of data should be "0x61 0x64 0x6D 0x69 0x6E 0x0D 0x0A" (Hex). If the password is correct, the module returns "OK", on the other hand, return to the "NO" and disconnect.

The TCP connection of this function can be Webpage in "TCP connection password authentication" is opened or disable. Please refer to the specific "5.1.6" section.

4.8.2 Upload ID

This function only applies to the module as a TCP client, in front of the data when module connected to the server with two bytes of ID (ID the range is 0 ~ 65535, the high byte before, and the low byte behind) plus two bytes ID radix-minus-one complement (or upload 6 bytes MAC address). Module is the default ID is 1111 (MAC: D8B04CF20000), for example, is sent to the

server when the first four bytes "0x57 0x04 0xfb 0xa8"(or "0xD8 0xB0 0x4C 0xF2 0x00 0x00").

There are two ways to upload their own id: one is to upload their own ID/MAC for connection to the server for the first time;The other is a plus ID/MAC in front of each data.

Registered Package related parameter is set in the "serial port and other Settings" section of the web, build joint function of ID/MAC for the first time, and each data with the function of ID/MAC are disabled by default.

Note: the function of the upload MAC supported in V5.01D.14 and above version.

4.8.3 Self-adaption Baudrate

This feature, please cooperate with our company's virtual serial port software use.

Use a serial port connected module, and use the at command "at + AABR = on" open this function and restart.In the USR - VCOM software "synchronous baud rate (RFC2217 similar)" is selected, the following figure.

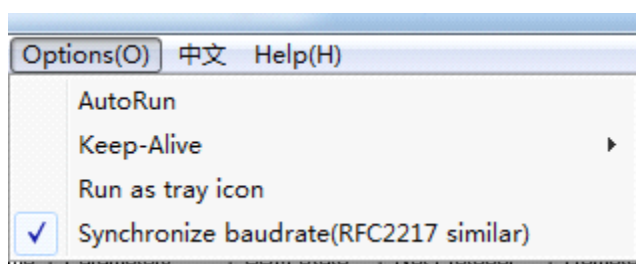

Figure 27 **RFC 2217**

In this way, the module of baud rate will be as the USR-VCOM to change at any time, and don't have to restart the module.If restart the module, baud rate and will come back to before.

4.8.4 WEB IO

This function only work for "GPIO mode".

When the module is in the "GPIO mode", enter the Webpage in "WEB IO", you can click on the corresponding button to control module pin level. Without the need to download and install app, any platform, any equipment, as long as you can into the built-in Webpage of module through the browser built-you can control module pin of IO.

4.8.5 Keepalive

V4.02.10. USR13 and above version of the firmware added keepalive when the TCP connection mechanism, so when the module of network anomalies, timely diagnose abnormal to the network and disconnect, when the network has resumed after, and just in time to connect to the server.

4.8.6 Multiple STA parameters

This function based on V4.02.10 D.U SR18 and above version of the firmware, in the sta mode, if can network signal is too low, it will automatically switch to the other AP network (switching network automatically restart).

This feature provides a signal threshold, when the current network signals is lower than the critical value, the module of automatic switching network and restart.If the signal value is set to 100, the module will not switch network.Even if the current network signal is not the current network will always search, not heavy to other networks.

The function of the specific Settings page refer to section 4.5.4.

4.8.7 Websocket

This module can realize the function of the websocket server, allowing serial real-time interaction with the web module, replace the previous HTTP GET, POST, corresponding faster. This module provides the corresponding websocket test page for user testing, specific page is as follows: (web Page: 10.10.100.254/websocketen.html)

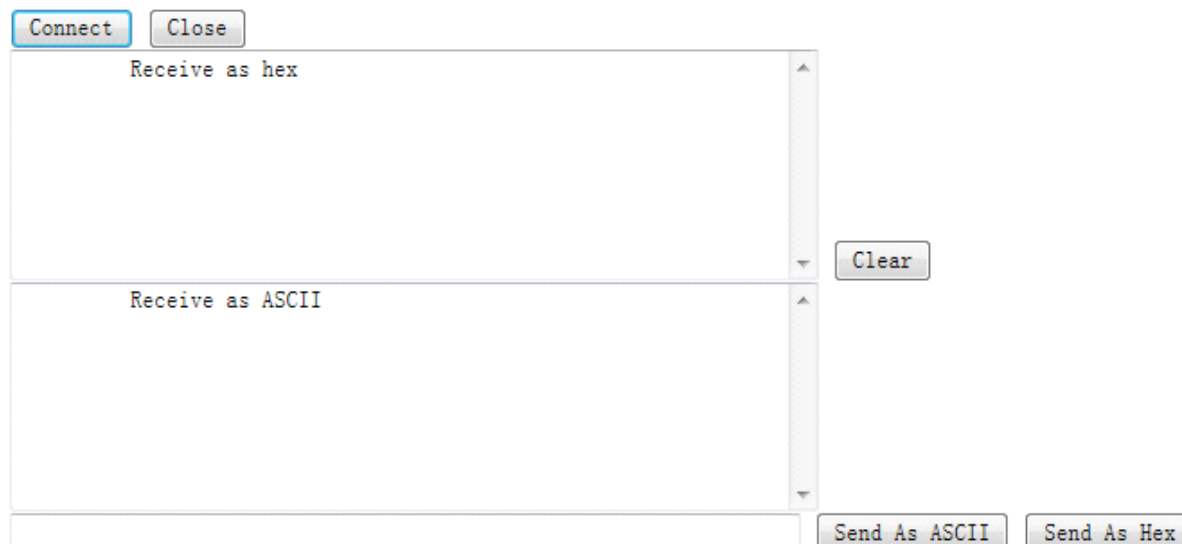

Figure 28 **Websocket Page**

Click on the "connect" page and then implements a connection, so a serial port with page can send or receive data from each other. This module websocket server support 8 client connection at the same time.

This function for web applications, and for web users with higher response speed, if you want to customize the corresponding web page, can connect your company.

Note: this function take up the 8000 port of module.

4.8.8 Fast access Wi-Fi(uslink)

[This function is based on V5.01.08 and above version of the firmware.](#)

When one module works in AP mode, it opens a UDP port used to receive fast access Wi-Fi commands, the port number is 49000. The phone PDA can directly connect to Wi-Fi network of the module, send commands to search router list and set SSID and password. After the completion of set up, module will automatically restart, connected to the router, work in the STA mode at this time.

Protocol format

Searching command

No	Name	Num of Bytes	Description
1	head	1	fixed value:0xFF
2	length	2	Sum of data bytes from length bytes to check byte(not contain length bytes and check byte).
3	cmd	1	Command type, 0x01
4	check	1	Sum of bytes from head (not contained) byte to check byte (not contained).

Response for searching

No	Name	Num of Bytes	Description
1	head	1	fixed value:0xFF

2	length	2	Sum of data bytes from length bytes to check byte(not contain length bytes and check byte).
3	cmd	1	Command type, 0x81
4	AP num	1	The number of AP what module scans
5	SSID1	Unsize	The SSID of router 1
6	separator	1	Separator of SSID1, fixed value:0x00
7	Signal strength1	1	Signal strength of router 1,0~100: 0%~100%
8	separator	2	Separator of signal strength1, fixed value: 0x0D,0x0A
...
M	SSID n	Unsize	The SSID of router n
M+1	separator	1	Separator of SSID n, fixed value:0x00
M+2	Signal strength	1	Signal strength of router n,0~100: 0%~100%
M+3	separator	2	fixed value:0x0D,0x0A
M+4	check	1	Sum of bytes from head (not contained) byte to check byte (not contained).

Example:

Data from phone PDA to module (HEX): FF 00 01 01 02

Data from module to phone PDA (HEX): FF 00 14 81 02 54 45 53 54 31 00 40 0D 0A 54 45 53 54 32 00 37 0D 0A 1F

Explanation:

The phone PDA send searching command to module, the response from module is: SSID of router1 is "TEST1", signal strength of router1 is 64%; SSID of router2 is "TEST2", signal strength of router2 is 55%.

Note: The information of routers is ordered by signal strength.

Setting command

No	Name	Num of Bytes	Description
1	head	1	fixed value:0xFF
2	length	2	Sum of data bytes from length bytes to check byte (not contain length bytes and check byte).
3	cmd	1	Command type, 0x02
4	reserve	1	fixed value:0x00
5	SSID	Unsize	SSID of router
6	separator	2	fixed value:0x0D,0x0A
7	password	Unsize	Password of router
8	check	1	Sum of bytes from head (not contained) byte to check byte (not contained).

Response for setting

No	Name	Num of Bytes	Description
1	head	1	fixed value:0xFF
2	length	2	Sum of data bytes from length bytes to check byte(not contain length bytes and check byte).
3	cmd	1	Command type, 0x82
4	Check for SSID	1	If the SSID set by PDA exist, check value is 0x01, otherwise is 0x00.
5	Check for password	1	If the form of password set by PDA is correct, check value is 0x01, otherwise is 0x00.
6	check	1	Sum of bytes from head (not contained) byte to check byte (not contained).

Example:

Data from phone PDA to module (HEX): FF 00 0F 02 00 54 45 53 54 31 0D 0A 31 32 33 34 35 36 CE

Data from module to phone PDA (HEX): FF 00 03 82 01 01 87

Explanation:

The phone PDA send setting command to module, SSID is set to "TEST1", password is set to "123456". The response from module is that the "TEST1" Wi-Fi network exist, the form of password is correct.

4.8.9 Software flow control

V5.01.18 above version supports serial software flow control function, it can be set up in the web page can also use the AT instruction to set (specifically, please refer to the AT+UART directive). In the software flow control, the transmitted data must be visible ASCII characters, and if the non-visible characters can be transmitted to the software flow control.

4.8.10 Domain backup and Smart Station

V5.01.18 above version adds domain name backup function. After opening the function, when the module is connected the server which is the domain name.it will automatically save the IP address of the domain name, If it disconnect, and it don't even have a server for five minutes.(including unable to parse the IP domain or to resolve IP connection could not be established) automatically enabled standby IP connection.

This feature can be turned on or off in a web page, or AT instruction (AT+IPBUP).

V5.01.18 or more versions adds Smart Station function. If the module is in STA mode, and five minutes without connecting to the router, then the module will automatically start its own AP function, and every 80 seconds to connect a router. This feature facilitates the user to continue with the wireless control module, or to set the parameters of the module.

This feature has been close.

4.9 Palmodic Signal

Base on selected factory default setting, "Ready" signal can have two output statuses:

- ✧ Status One: The module will output "0" after normal boot up. This signal used to judge if module finish boot up and ready for application.
- ✧ Status Two: The module will output "Palmodic Signal" after normal boot up.The palmodic signal is 0.5Hz square wave with dutyfactor 1:1. User can query this signal to judge if module is active "live" or need to re-boot. When module switches to command mode, it will output "0" , which used to distinguish work mode and command mode.

Notes:

This function is user selected factory setting and RELD instruction will not effective for this function. If user not requires this function, the default factory setting is Status One. Contact with USR Technology for more detailed support.

4.10 Parameters Configuration

USR-WIFI232-D2 module supports two methods to configuration parameters: **Web Accessing** and **AT+Instruction set**.

Web accessing means users can configure parameters through built-in webpage. When USR-WIFI232-D2 module connected to wireless network, parameters configuration is done on a PC connected to the same wireless network. AT+instruction set configuration means user configure parameters through serial interface command. Refer to “AT+instruction set” chapter for more detail.

Notes:

USR can customized the parameters setting as customer request and ship USR-WIFI232-D2 modules with these parameters as factory default configuration. It will reduce user's module configuration time for mass production. Also, if user need different parameters setting for every module, USR can provide the auto-configuration tool to speed up the module configuration duration. Please contact USR technical interface to acquire this tool if required.

4.11 Firmware Upgrade

USR-WIFI232-D2 module supports firmware upgrade online.

5 Web Accessing and AT+instruction set

5.1 Configuration via Web Accessing

When first use USR-WIFI232-D2 modules, user may need some configuration. User can connect to USR-WIFI232-D2 module's wireless interface with following default setting information and configure the module through laptop.

Table 7 **USR-WIFI232-D2 Web Access Default Setting**

Parameters	Default Setting
SSID	USR-WIFI232-D2_XXXX
IP Address	10.10.100.254
Subnet Mask	255.255.255.0
User Name	admin
Password	admin

5.1.1 Open Web Management Interface

Step 1: Connect laptop to SSID "USR-WIFI232-D2_XXXX" of USR-WIFI232-D2 module via wireless LAN card;

Step 2: After wireless connection OK. Open browser and access "<http://10.10.100.254>";

Step 3: Then input user name and password in the page as following and click "OK" button.



Figure 29 **Open Web Management page**

The USR-WIFI232-D2 web management page support English and Chinese language. User can select language environment at the top right corner and click "Apply" button.

The main menu include nine pages: "Quick Configure","Mode Selection"," AP Interface Setting","STA Interface Setting","Application Setting", "Ethernet Setting","HTTPD Client mode","WEB IO"and "Device Management".

5.1.2 Quick Configure

This page provides users with a method of rapid configuration module. Users according to the steps to configure the parameters and restart the module page, you can let the module is normal work, reduced the configuration steps and time. Of course the options on this page is less, if some detailed configuration, still need to the corresponding configuration page.

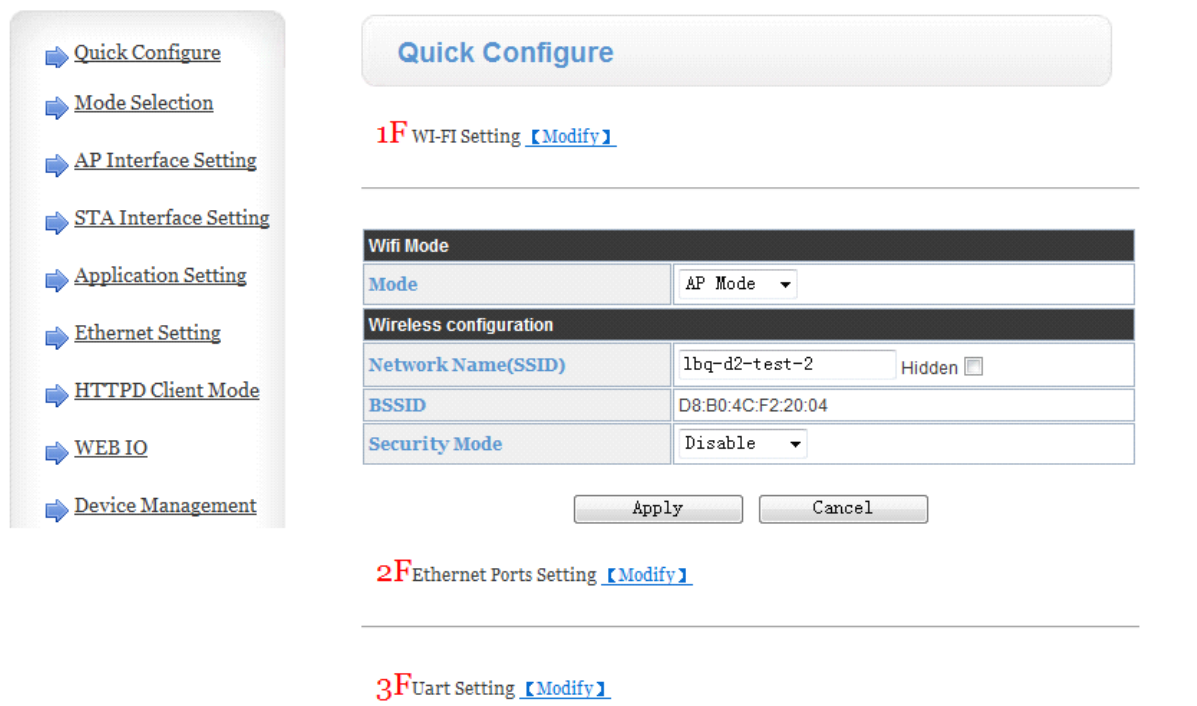

- ➔ [Quick Configure](#)
- ➔ [Mode Selection](#)
- ➔ [AP Interface Setting](#)
- ➔ [STA Interface Setting](#)
- ➔ [Application Setting](#)
- ➔ [Ethernet Setting](#)
- ➔ [HTTPD Client Mode](#)
- ➔ [WEB IO](#)
- ➔ [Device Management](#)

Quick Configure

1F WI-FI Setting [【Modify】](#)

Wifi Mode	
Mode	AP Mode ▾
Wireless configuration	
Network Name(SSID)	1bq-d2-test-2 <input type="checkbox"/> Hidden
BSSID	D8:B0:4C:F2:20:04
Security Mode	Disable ▾

2F Ethernet Ports Setting [【Modify】](#)

3F Uart Setting [【Modify】](#)

Figure 30 **Quick Configure Page**

This page has four configuration options and a restart, the corresponding instructions below:

- ◆ **WI-FI Setting:** set the working mode of wifi, AP mode or the STA.
- ◆ **Ethernet Ports Setting:** open/close the Ethernet ports, and set up the corresponding work mode.
- ◆ **UART Setting:** set serial port parameters, including baud rate, parity bit, 485 functions and so on.
- ◆ **Network Setting:** set network parameters, Only TCPA related parameters.
- ◆ **Device Management:** when after completion of the above parameters are configured, click reset module.

5.1.3 Mode Selection Page

This page use to setting the wireless networking mode (AP and STA mode).

"Data transmission mode" selection module working mode are "Transparent Mode", "Serial Command mode", "GPIO mode"and"HTTPD-Client Mode".

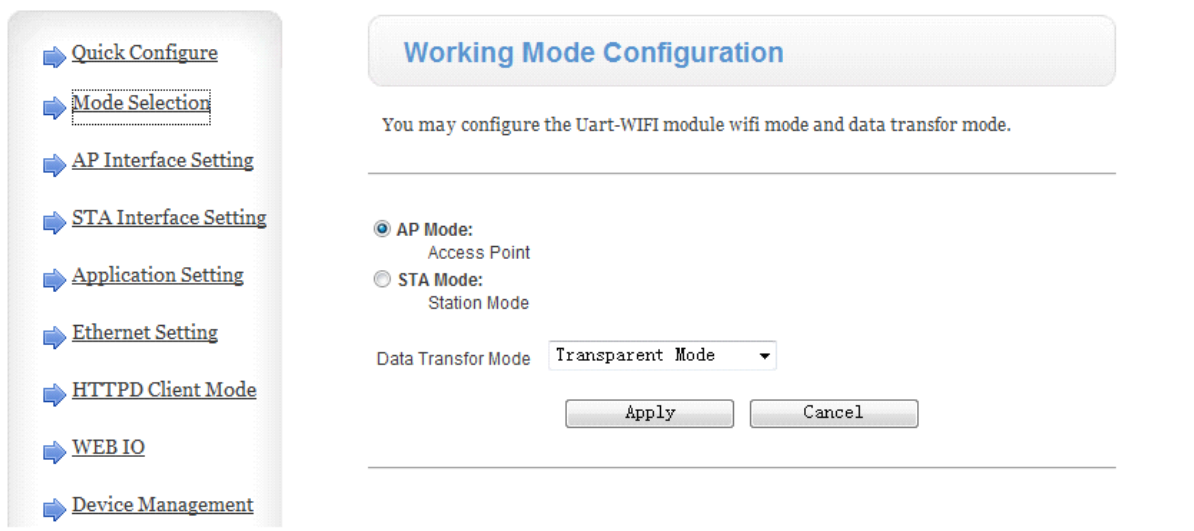

Figure 31 **Mode Selection Page**

5.1.4 AP Interface Setting Page

This page use to setting the parameters when USR-WIFI232-D2 module works as AP.

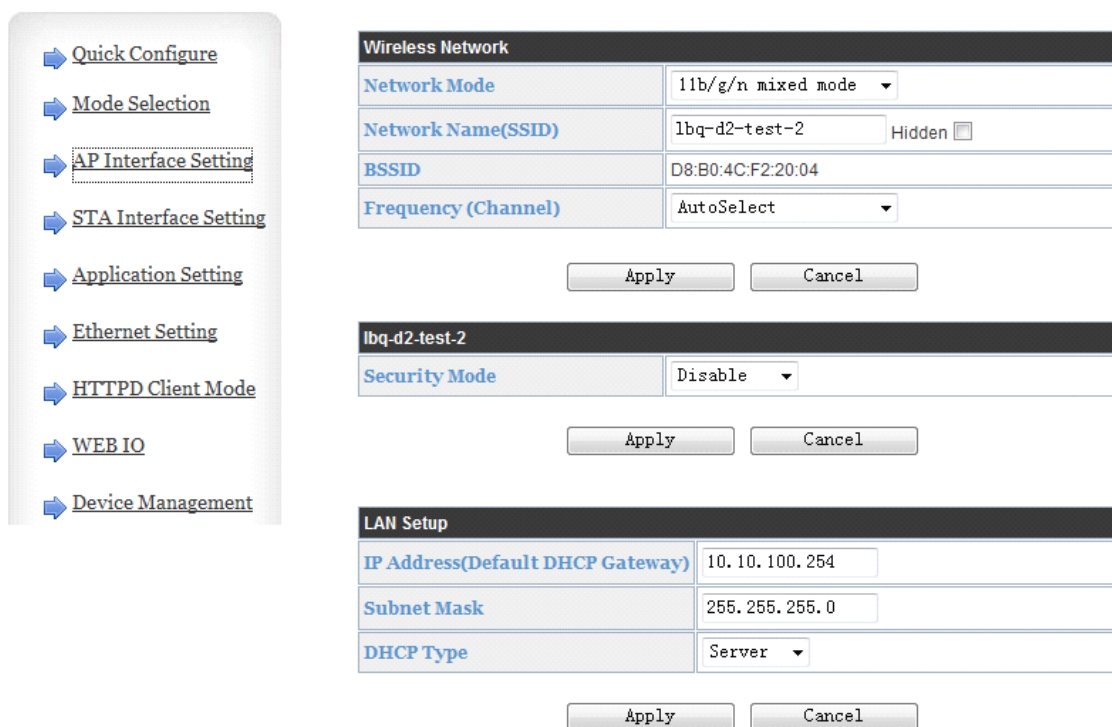

Figure 32 **AP Interface Setting Page**

5.1.5 STA Interface Setting Page

This page use to setting the parameters when USR-WIFI232-D2 module works as STA.

Such as SSID of AP which module need to connected, and also select the networking type: DHCP or static IP address.

- ➔ [Quick Configure](#)
- ➔ [Mode Selection](#)
- ➔ [AP Interface Setting](#)
- ➔ [STA Interface Setting](#)
- ➔ [Application Setting](#)
- ➔ [Ethernet Setting](#)
- ➔ [HTTPD Client Mode](#)
- ➔ [WEB IO](#)
- ➔ [Device Management](#)

STA Interface Parameters	
AP1's SSID	USR-WIFI232-AP4 <input type="text" value="Search..."/>
MAC Address1 (Optional)	<input type="text"/>
Security Mode1	OPEN ▾
Encryption Type1	NONE ▾
AP2's SSID	USR-WIFI232-AP2 <input type="text" value="Search..."/>
MAC Address2 (Optional)	<input type="text"/>
Security Mode2	OPEN ▾
Encryption Type2	NONE ▾
AP3's SSID	USR-WIFI232-AP3 <input type="text" value="Search..."/>
MAC Address3 (Optional)	<input type="text"/>
Security Mode3	OPEN ▾
Encryption Type3	NONE ▾
Signal threshold	2 % Note: The signal is less than this value, Switching network

Figure 33 **STA Interface Setting Page**

5.1.6 Application Setting Page

This page use to setting the parameters of serial port communication, such as UART setting,UART AutoFrame Setting,Ethernet function,Device ID setting and high layer network protocol setting which used support serial communication.

- ➔ [Quick Configure](#)
- ➔ [Mode Selection](#)
- ➔ [AP Interface Setting](#)
- ➔ [STA Interface Setting](#)
- ➔ [Application Setting](#)
- ➔ [Ethernet Setting](#)
- ➔ [HTTPD Client Mode](#)
- ➔ [WEB IO](#)
- ➔ [Device Management](#)

Uart Setting	
Baudrate	57600 ▾
Data Bits	8 ▾
Parity	None ▾
Stop	1 ▾
CTSRTS	Disable ▾
485 mode	Disable ▾
Baudrate adaptive (RFC2117)	Enable ▾

UART AutoFrame Setting	
UART AutoFrame	Disable ▾

Device ID setting	
Device ID (0-65535)	1111 <input type="text"/>
Send an ID when module connection is established	Enable ▾

<ul style="list-style-type: none"> ➔ Quick Configure ➔ Mode Selection ➔ AP Interface Setting ➔ STA Interface Setting ➔ Application Setting ➔ Ethernet Setting ➔ HTTPD Client Mode ➔ WEB IO ➔ Device Management 	<input type="button" value="Apply"/> <input type="button" value="Cancel"/>																										
<table border="1" style="width: 100%; border-collapse: collapse;"> <thead> <tr style="background-color: #333; color: white;"> <th colspan="2">Network A Setting</th> </tr> </thead> <tbody> <tr> <td>Mode</td> <td>Server ▾</td> </tr> <tr> <td>Protocol</td> <td>TCP ▾</td> </tr> <tr> <td>Port</td> <td>8899</td> </tr> <tr> <td>Server Address</td> <td>10.10.100.100</td> </tr> <tr> <td>MAX TCP Num. (1-32)</td> <td>32</td> </tr> <tr> <td>TCP Time out (MAX 600 s)</td> <td>0</td> </tr> <tr> <td>TCP connection password authentication</td> <td>Disable ▾</td> </tr> <tr style="background-color: #333; color: white;"> <th colspan="2">Socket B Setting</th> </tr> <tr> <td>Open the SocketB function</td> <td>on ▾</td> </tr> <tr> <td>Port</td> <td>8899</td> </tr> <tr> <td>Server Address</td> <td>www.zhangkongbao.com</td> </tr> <tr> <td>TCPB Time out (MAX 600 s)</td> <td>0</td> </tr> </tbody> </table>		Network A Setting		Mode	Server ▾	Protocol	TCP ▾	Port	8899	Server Address	10.10.100.100	MAX TCP Num. (1-32)	32	TCP Time out (MAX 600 s)	0	TCP connection password authentication	Disable ▾	Socket B Setting		Open the SocketB function	on ▾	Port	8899	Server Address	www.zhangkongbao.com	TCPB Time out (MAX 600 s)	0
Network A Setting																											
Mode	Server ▾																										
Protocol	TCP ▾																										
Port	8899																										
Server Address	10.10.100.100																										
MAX TCP Num. (1-32)	32																										
TCP Time out (MAX 600 s)	0																										
TCP connection password authentication	Disable ▾																										
Socket B Setting																											
Open the SocketB function	on ▾																										
Port	8899																										
Server Address	www.zhangkongbao.com																										
TCPB Time out (MAX 600 s)	0																										
<input type="button" value="Apply"/> <input type="button" value="Cancel"/>																											

Figure 34 **Application Setting Page**

Notes:

Generally, Network protocols support three modes: **TCP Server**, **TCP Client**, **UDP Server**, **UDP Client**.

When the module is configured to UDP server side, the module will memory the UDP client end of the last communication, and communication with this UDP client. While the UDP client mode will only with the target IP address and communication. When set to the TCP Server, do not need to enter the IP address. For other Settings, need to fill in the need to connect each other IP address. Fill in port with protocol port number, at the ends of the communication port number must be the same.

The Socket B only as a TCP client terminal to communicate with the server.

TCP connection password authentication: when the module in the TCP server mode, password authentication on the TCP client connect to.

Note: this verification is only in a module as a TCP server. After the opening, the TCP client connected module, the first data which sent to the module is password and carriage returns. The password is the password to login page default is "admin". Such as the default when sending the first data should be "0x61 0x64 0x6D 0x69 0x6E 0x0D 0x0A" (hex).

5.1.7 Ethernet Setting

This page is used to set two Ethernet front-end ports of the module, two Ethernet front-end ports can be open or closed. And so the second can be set to the WAN port to use, this module can be used as a secondary router, making it easy for users to network. Specific Settings page is as follows:

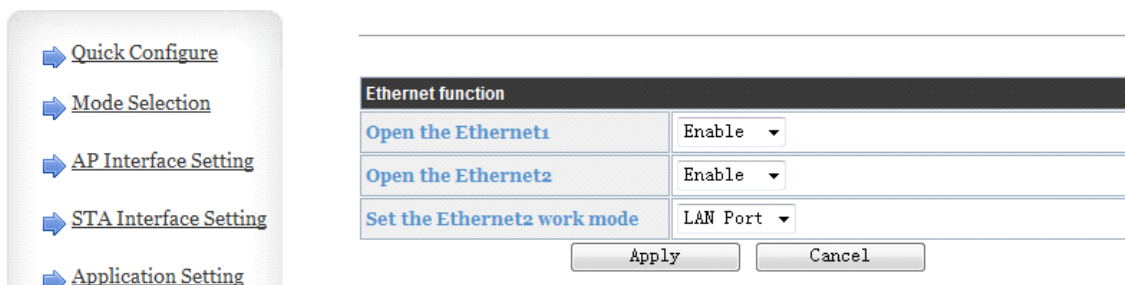

Figure 35 Ethernet Setting Page

5.1.8 HTTPD Client Mode

This page sets the HTTP header in the HTTPD Client mode. Include: the address of the server, the server port, request type, protocol header path, Connection, user-agent.

HTTPD Client mode support POST, PUT, GET three HTTP request types. Is a POST or PUT request way, serial data can be added to the back of the HTTP header; When the request is a GET, data can be added to the back of the path in the HTTP header. The specific way of sending data can consult section 4.2.4.

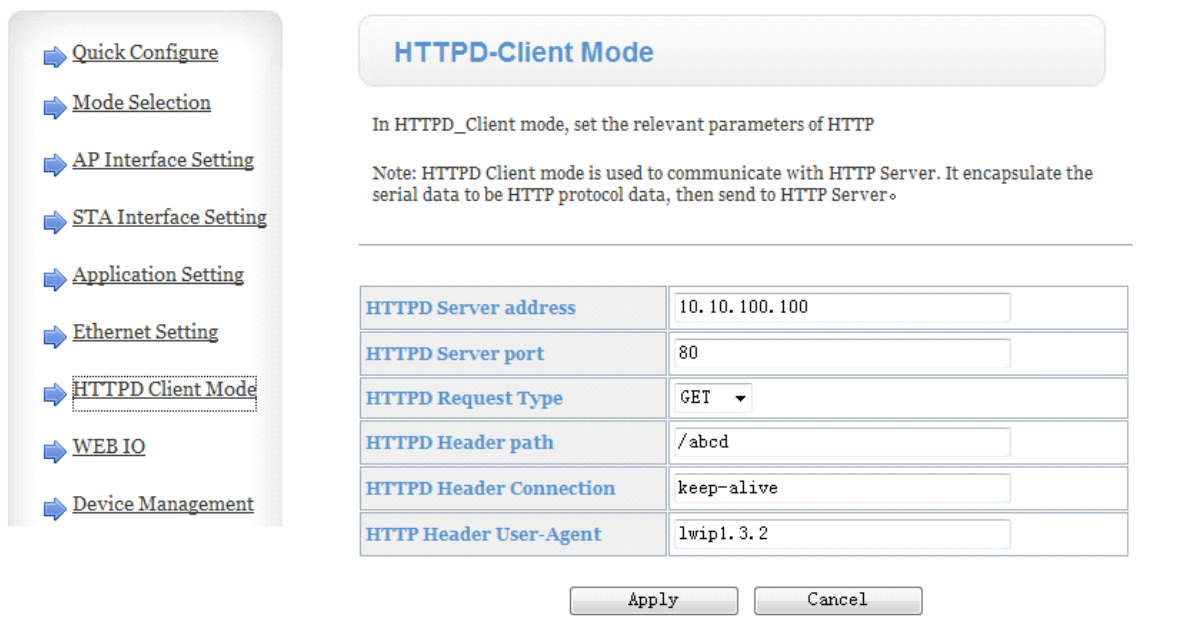

Figure 36 HTTPD Client Mode Page

5.1.9 WEB IO

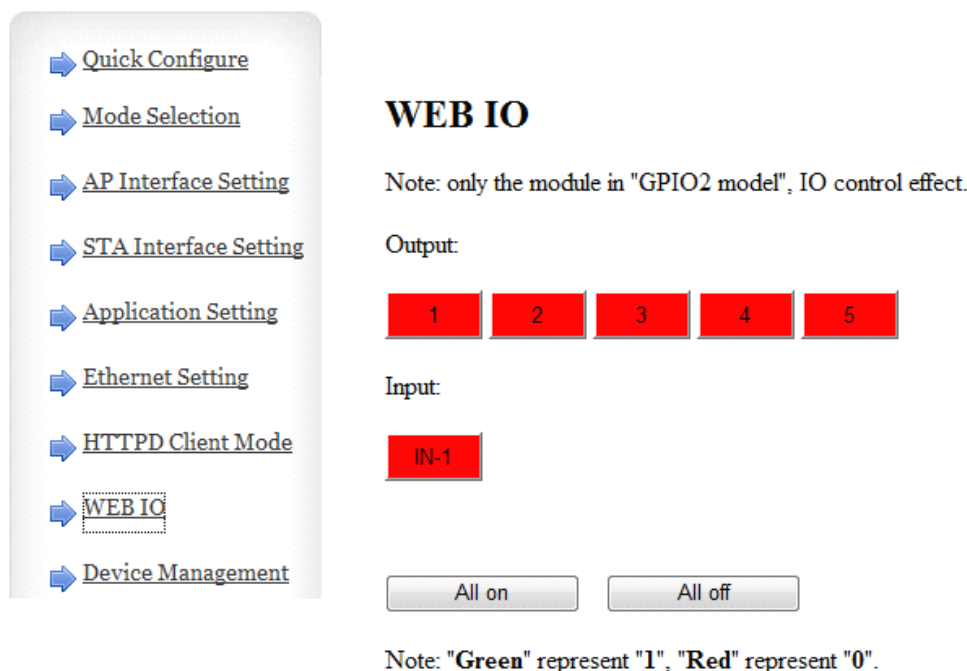

Figure 37 **WEB IO Page**

5.1.10 Advanced Page

Under the advanced Settings page, the user can set the port mapping and function of DDNS, without having to go on a router Settings, reduce the complexity of setting, the port mapping and DDNS, can be in the public environment, by entering the peanut shell domain name and port, can quickly and easily find the module.

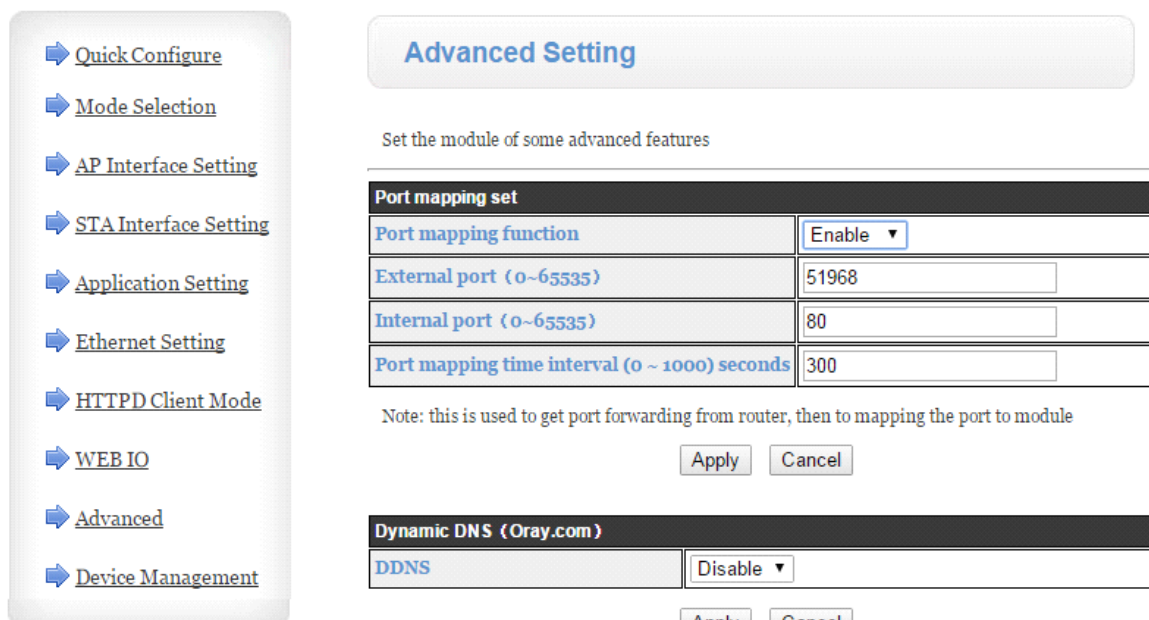

Figure 38 **Advanced Setting Page**

5.1.11 Device Management Page

This page use to manage USR-WIFI232-D2 module general setting, such as administrator setting, restart module button, restore factory default setting button, and update firmware through webpage.

- [Mode Selection](#)
- [AP Interface Setting](#)
- [STA Interface Setting](#)
- [Application Setting](#)
- [Device Management](#)

Device Management

4.01.11

You may configure administrator account and password, load default setting or update firmware.

Administrator Settings

Account	<input type="text" value="admin"/>
Password	<input type="text" value="admin"/>

Restart Module

Restart Module	<input type="button" value="Restart"/>
-----------------------	--

Load Factory Defaults

Load Default Button	<input type="button" value="Load Default"/>
----------------------------	---

Update Firmware

Location:	<input type="text"/> <input type="button" value="Browse..."/>
------------------	---

Figure 39 **Device Management Page**

Notes:

Restart module button: When you setting the parameters of different web pages, you will click “Apply” button to confirm the setting, but the setting take effect only after user click the “Restart” button here, the module will re-boot up and refresh the memory information with new changes.

5.2 AT+instruction Introduction

5.2.1 Configuration Mode

When USR-WIFI232-D2 power up, it will default works as transparent transmission mode, then user can switch to configuration mode by serial port command. USR-WIFI232-D2 UART default parameters setting as below figure

Uart Setting	
Baudrate	<input type="text" value="57600"/>
Data Bits	<input type="text" value="8"/>
Parity	<input type="text" value="None"/>
Stop	<input type="text" value="1"/>
CTSRTS	<input type="text" value="Disable"/>

Figure 40 **USR-WIFI232-D2 Default UART Port Parameters**

In configuration mode, user can setting the module through AT+ instruction set, which cover all web page setting function.

5.2.1.1 Switch to Configuration Mode

Two steps to finish switching from transparent transmission mode to configuration mode.

- **UART input “+++”, after module receive “+++”, and feedback “a” as confirmation.**
- **UART input “a”, after module receive “a” and feedback “+ok” to go into AT+ instruction set configuration mode.**

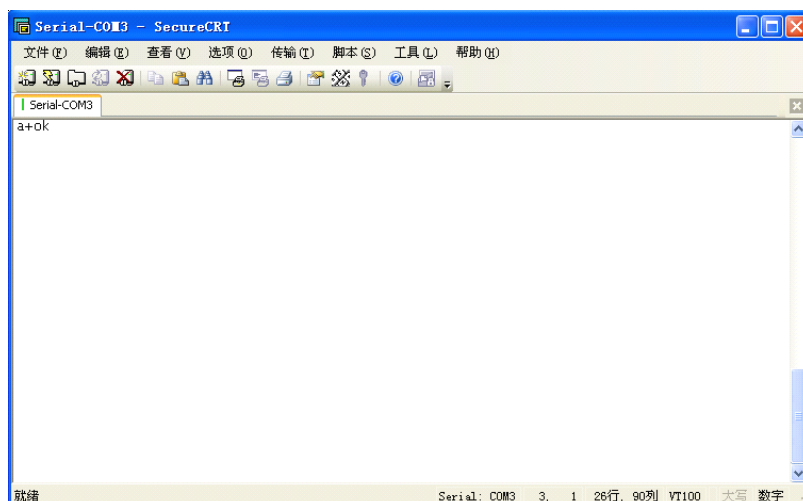
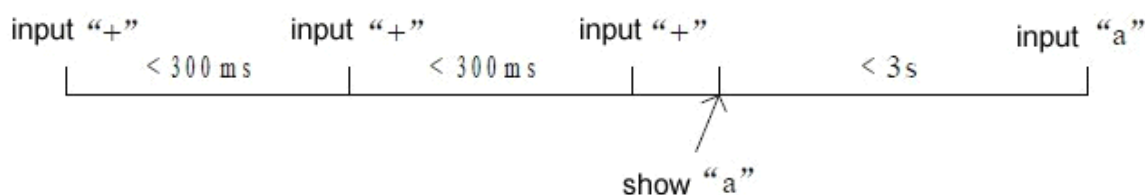

Figure 41 **Switch to Configuration Mode**

Notes:

1. When user input “+++” (No “Enter” key required), the UART port will display feedback information “a”, and not display input information “+++” as above UART display.
2. Any other input or wrong step to UART port will cause the module still works as original mode (transparent transmission).



5.2.2 AT+ Instruction Set Overview

User can input AT+ Instruction through hyper terminal or other serial debug terminal, also can program the AT+ Instruction to script. User can also input “AT+H” to list all AT+ Instruction and description to start.

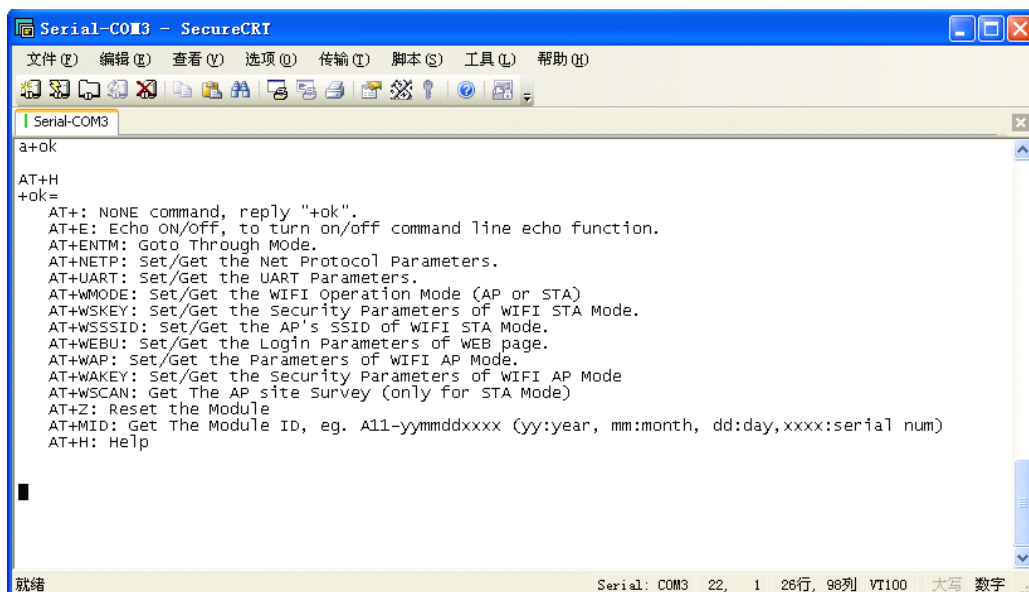

Figure 42 **"AT+H" Instruction for Help**

We supply software USR-WIFI232-Setup to send command easily, software setup:

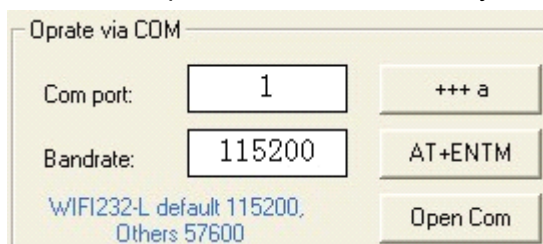

Figure 43 **Serial port parameter**

Click "Open Com", send "+++a", it will reply +ok in left side, then type in and send the command you need to send, then click "AT+RELD" to restore, then parameters saved.

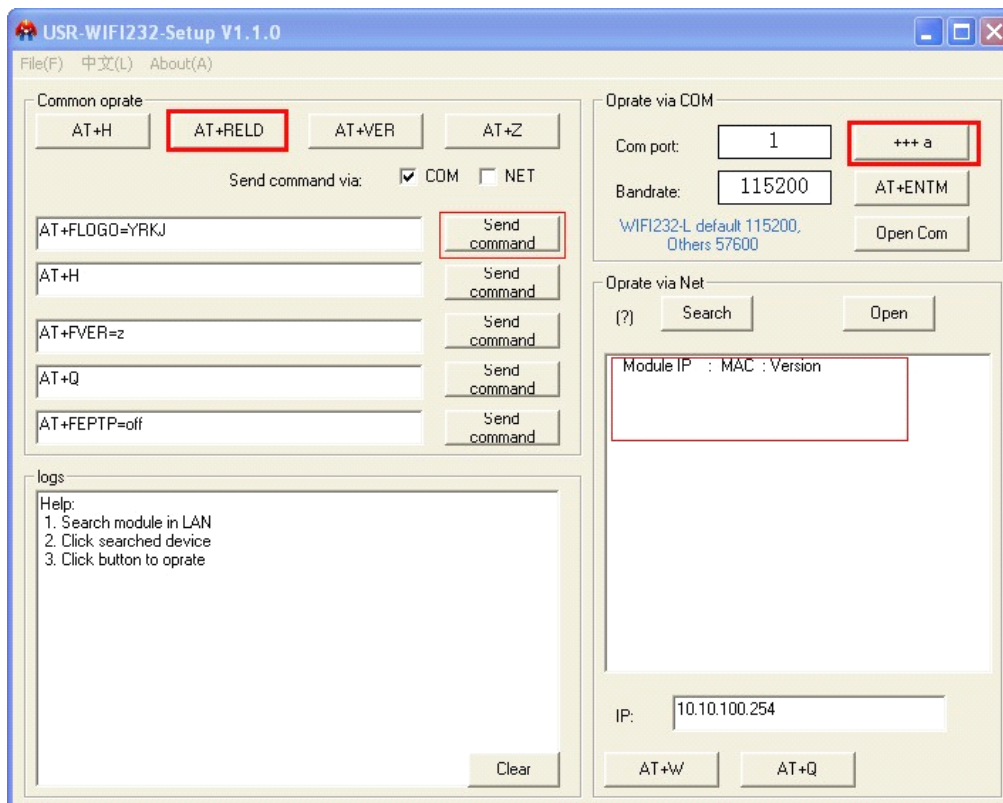

Figure 44 software of USR-WIFI232-Setup

Above is by COM, also you can send by WIFI:
 First, connect with PC, open the software, see Net part

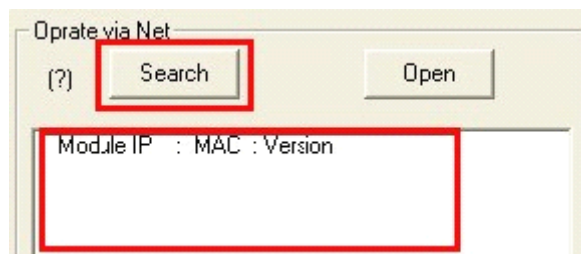

Figure 45 Search module

Click search, then will show module, click module then you can send command.

5.2.2.1 Instruction Syntax Format

AT+Instruction protocol is based on the instruction of ASCII command style, the description of syntax format as follow.

- **Format Description**
 - < >: Means the parts must be included
 - [:]: Means the optional part
- **Command Message**

AT+<CMD>[op][para-1,para-2,para-3,para-4...]<CR>

- AT+: Prefix of command message;
 - CMD: Command string;
 - [op]: Symbol of command operator,
 - ◆ “=” : The command requires parameters input;
 - ◆ “NULL”: Query the current command parameters setting;
 - [para-n]: Parameters input for setting if required;
- <CR>: "Enter" Key, it's 0x0a or 0x0d in ASCII;

Notes: When input AT+Instruction, “AT+<CMD>” character will display capital letter automatic and other parts will not change as you input.

➤ **Response Message**

+<RSP>[op] [para-1,para-2,para-3,para-4...]<CR><LF><CR><LF>

- +: Prefix of response message;
- RSP: Response string;
 - ◆ “ok” : Success
 - ◆ “ERR”: Failure
- [op] : =
- [para-n]: Parameters if query command or Error code when error happened;
- <CR>: ASCII 0x0d;
- <LF>: ASCII 0x0a;

➤ **Error Code**

Table 8 **Error Code Description USR-WIFI232-D2 Web Access Default Setting**

Error Code	Description
-1	Invalid Command Format
-2	Invalid Command
-3	Invalid Operation Symbol
-4	Invalid Parameter
-5	Operation Not Permitted

5.2.2.2 AT+ Instruction Set

Table 9 **AT+ Instruction Set List**

Instruction	Description
<null>	NULL
E	Open/Close show back function
ENTM	Set module into transparent transmission mode
NETP	Set/Query network protocol parameters
UART	Set/Query serial port parameters
UARTF	Open/Close UART auto-frame function
UARTFT	Set/Query UART auto-frame trigger time

UARTFL	Set/Query UART auto-frame trigger length
TMODE	Set/Query data transmission mode (transparent transmission or agreement transmission)
WMODE	Set/Query WIFI work mode (AP or STA)
WSKEY	Set/Query WIFI security parameters as STA
WSSID	Set/Query WIFI target AP SSID parameters as STA
WSLK	Query WiFi link status as STA
WEBU	Set/Query WEB page login parameters (User Name and Password)
WAP	Set/Query WIFI parameters as AP
WAKEY	Set/Query WIFI security parameters as AP
HIDESSID	Set/Query hide AP's SSID
MSLP	Set modules into power save mode.(Turn OFF WiFi)
WSCAN	Seek AP when module works as STA mode
TCPLK	Query if TCP link already build-up
TCPDIS	Open/Close TCP (Only TCP Client available)
WANN	Set/Query WAN setting, only effective as STA mode
LANN	Set/Query LAN setting, only effective as AP mode
DHCPDEN	Enable/Disable LAN DHCP server function
DHCPGW	Set/Query DHCP gateway address
TCPTO	Set/Query TCP timeout
MAXSK	Set/Query maxima TCP connection
TCPB	Open/Close TCPB function
TCPTB	Set/Query TCPB port number
TCPADDB	Set/Query TCPB server address
TCPTOB	Set/Query TCPB time out time
TCPLKB	Query TCPB link status
STTC	Enable/Disable STA port scan function
DOMAIN	Set/Query domain of module webpage
RELD	Restore to factory default setting
FUDLX	Open / close the 485 function
MMID	Device ID
IDFIR	Send an ID when module connection is established
IDEVE	Every time to send data to send ID
AABR	Open / close baud rate adaptive function
MID	Query module ID information
VER	Query module software version information
H	Help
HTTPURL	Set /Query HTTP server IP address and Port Number
HTTPTP	Set /Query HTTP request type
HTTPPH	Set/Query HTTP protocol header path
HTTPCN	Set/Query Connection of HTTP protocol header
HTTPIA	Set/Query User-Agent of HTTP protocol header
EPHYA	Open/Close ETH1 interface
EPHYB	Open/Close ETH2 interface
WSSSIDA	Set/query the first AP's ssid of 3 sta parameters settings
WSSSIDB	Set/query the second AP's ssid of 3 sta parameters settings
WSSSIDC	Set/query the third AP's ssid of 3 sta parameters settings
WSKEYA	Set/query the first AP's password of 3 sta parameters settings
WSKEYB	Set/query the second AP's password of 3 sta parameters settings
WSKEYC	Set/query the third AP's password of 3 sta parameters settings
WSQY	Set/query the criticacl value of network switching

HTPMODE	The switch of new/old HTTP headers setting mode(HTTPD Client)
HTPSV	Under the new mode,Settings/query server and IP address(HTTPD Client)
HTPTP	Under the new mode,Settings/query request type(HTTPD Client)
HTPURL	Under the new mode,setting/query request path(HTTPD Client)
HTPHEAD	Under the new mode,Settings/query the HTTP header(HTTPD Client)
REGEN	Settings/query Registered Package Type
REGTCP	Settings/query Upload Manner
REGID	Settings/query Device ID
IPBUP	Set and query domain IP backup function
STAPRO	Set and query Smart Station function

Notes: USR-WIFI232-D2 module can works as AP or STA, user have to use different AT+ Instruction to set WiFi parameters when module works as AP or STA mode.

5.2.2.2.1 AT+E

- Function: Open/Close show back function;
- Format:

AT+E<CR>

+ok<CR>< LF ><CR>< LF >

When USR-WIFI232-D2 module firstly switch from transparent transmission to configuration mode, show back status is open, input “AT+E” to close show back function, input“AT+E” again to open show back function.

5.2.2.2.2 AT+ENTM

- Function: Set module into transparent transmission mode;
- Format:

AT+ENTM<CR>

+ok<CR>< LF ><CR>< LF >

When operate this command, module switch from configuration mode to transparent transmission mode.

5.2.2.2.3 AT+NETP

- Function: Set/Query network protocol parameters;
- Format:
 - ◆ Query Operation

AT+NETP<CR>

+ok=<protocol,CS,port,IP><CR>< LF ><CR>< LF >

- ◆ Set Operation

AT+NETP=<protocol,CS,port,IP><CR>

+ok<CR>< LF ><CR>< LF >

- Parameters:
 - ◆ protocol:
 - ✧ TCP

- ◇ UDP
- ◆ CS: Network mode:
 - ◇ SERVER
 - ◇ CLIENT
- ◆ Port: protocol port ID: Decimal digit and less than 65535
- ◆ IP: Server's IP address when module set as client

Note: when it's TCP server or UDP server, the server port can not be set to 80 (HTTP port), 8000 (websocket port), 49000 (usr-link port).

5.2.2.2.4 AT+UART

- Function: Set/Query serial port parameters;
- Format:
 - ◆ Query Operation

AT+UART<CR>

+ok=<baudrate,data_bits,stop_bit,parity,flowctrl><CR>< LF ><CR>< LF >

- ◆ Set Operation

AT+UART=<baudrate,data_bits,stop_bit,parity,flowctrl><CR>

+ok<CR>< LF ><CR>< LF >

- Parameters:
 - ◆ baudrate:
 - ◇ 300,600,1200,1800,2400,4800,9600,19200,38400,57600,115200,230400,345600,460800
 - ◆ data_bits:
 - ◇ 5,6,7,8
 - ◆ stop_bits:
 - ◇ 1,2
 - ◆ parity:
 - ◇ NONE,EVEN,ODD,MARK,SPACE
 - ◆ flowctrl: hardware flow control (CTSRTS)
 - ◇ NFC: No flow control
 - ◇ FC: flow control

After USR-WIFI232-D2 module boots up again, the setting will be effective.

5.2.2.2.5 AT+UARTF

- Function: Open/Close UART auto-frame function;
- Format:
 - ◆ Query Operation

AT+ UARTF<CR>

+ok=<para><CR>< LF ><CR>< LF >

- ◆ Set Operation

AT+ UARTF=<para ><CR>

+ok<CR>< LF ><CR>< LF >

- Parameters:
 - ◆ para:
 - ◇ disable - Close auto-frame function;

✧ enable - Open auto-frame function;

5.2.2.2.6 AT+UARTFT

- Function: Set/Query UART auto-frame trigger time;
- Format:

- ◆ Query Operation

AT+ UARTFT<CR>

+ok=<time><CR>< LF ><CR>< LF >

- ◆ Set Operation

AT+ UARTFT=<time ><CR>

+ok<CR>< LF ><CR>< LF >

- Parameters:
 - ◆ time: Range 100 ~10000; Unit: ms. Auto-frame trigger time

5.2.2.2.7 AT+UARTFL

- Function: Set/Query UART auto-frame trigger length;
- Format:

- ◆ Query Operation

AT+ UARTFL<CR>

+ok=<len><CR>< LF ><CR>< LF >

- ◆ Set Operation

AT+ UARTFL=<len ><CR>

+ok<CR>< LF ><CR>< LF >

- Parameters:
 - ◆ len: Range 64 ~4096; Unit: byte. Auto-frame trigger length;

5.2.2.2.8 AT+TMODE

- Function: Set/Query data transmission mode;
- Format:

- ◆ Query Operation

AT+TMODE<CR>

+ok=<tmode><CR>< LF ><CR>< LF >

- ◆ Set Operation

AT+ TMODE=<tmode><CR>

+ok<CR>< LF ><CR>< LF >

- Parameters:
 - ◆ tmode: Data transmission mode
 - ✧ Through: Transparent transmission
 - ✧ Agreement: Agreement transmission
 - ✧ Httpdclient: Httpd Client Mode
 - ✧ GPIO: GPIO Mode
 - ✧ modbus: Modbus TCP <=>Modbus RTU Mode

After USR-WIFI232-D2 module boots up again, the setting will be effective.

Note: No CMD.After power on, the module will not work in the AT command mode by default.

5.2.2.2.9 AT+WMODE

- Function: Set/Query WIFI work mode;
- Format:

- ◆ Query Operation

AT+WMODE<CR>

+ok=<mode><CR>< LF ><CR>< LF >

- ◆ Set Operation

AT+ WMODE=<mode><CR>

+ok<CR>< LF ><CR>< LF >

- Parameters:

- ◆ mode:WIFI work mode
 - ◇ AP
 - ◇ STA

After USR-WIFI232-D2 module boots up again, the setting will be effective.

5.2.2.2.10 AT+WSKEY

- Function: Set/Query WIFI security parameters as STA;
- Format:
 - ◆ Query Operation

AT+WSKEY<CR>

+ok=<auth,encry,key><CR>< LF ><CR>< LF >

- ◆ Set Operation

AT+ WSKEY=< auth,encry,key><CR>

+ok<CR>< LF ><CR>< LF >

- Parameters:

- ◆ auth: Authentication mode
 - ◇ OPEN
 - ◇ SHARED
 - ◇ WPAPSK
 - ◇ WPA2PSK
- ◆ encry:Encryption algorithm
 - ◇ NONE: When “auth=OPEN”, effective
 - ◇ WEP: When “auth=OPEN” or “SHARED”, effective
 - ◇ TKIP: When “auth= WPAPSK”, effective or “WPA2PSK”, effective
 - ◇ AES: When “auth= WPAPSK”, effective or “WPA2PSK”, effective
- ◆ key: password, ASCII code, shall less than 64 bit and greater than 8bit

This Instruction only effective for USR-WIFI232-D2 works as STA. After USR-WIFI232-D2 module boots up again, the setting will be effective. But user can set this command when module configured as AP.

5.2.2.2.11 AT+WSSSID

- Function: Set/Query WIFI target AP SSID parameters as STA.
- Format:
 - ◆ Query Operation

AT+WSSSID<CR>

+ok=<ap's ssid><CR>< LF ><CR>< LF >

- ◆ Set Operation

AT+ WSSSID=<ap's ssid ><CR>

+ok<CR>< LF ><CR>< LF >

- Parameters:
 - ◆ ap's ssid: AP's SSID

This Instruction only effective for USR-WIFI232-D2 works as STA. After USR-WIFI232-D2 module boots up again, the setting will be effective. But user can set this command when module configured as AP.

5.2.2.2.12 AT+ WSLK

- Function: Query WiFi link status as STA
- Format:
 - ◆ Query Operation

AT+ WSLK<CR>**+ok=<ret><CR>< LF ><CR>< LF >**

- Parameters:
 - ◆ ret
 - ◇ "Disconnected", if no WiFi connection;
 - ◇ "AP' SSID (AP's MAC") , if WiFi connection available;
 - ◇ "RF Off", if WiFi OFF;

This Instruction only effective for USR-WIFI232-D2 works as STA. After USR-WIFI232-D2 module boots up again, the setting will be effective. But user can set this command when module configured as AP.

5.2.2.2.13 AT+WEBU

- Function: Set/Query WEB page login parameters;
- Format:
 - ◆ Query Operation

AT+WEBU<CR>**+ok=<usr,password><CR>< LF ><CR>< LF >**

- ◆ Set Operation

AT+ WEBU=< usr,password ><CR>**+ok<CR>< LF ><CR>< LF >**

- Parameters:
 - ◆ usr: User name for WEB page access;
 - ◆ password: Password for WEB page access;

5.2.2.2.14 AT+WAP

- Function: Set/Query WIFI parameters as AP;
- Format:
 - ◆ Query Operation

AT+WAP<CR>**+ok=<wifi_mode,ssid,channel><CR>< LF ><CR>< LF >**

- ◆ Set Operation

AT+ WAP=<wifi_mode,ssid,channel><CR>**+ok<CR>< LF ><CR>< LF >**

- Parameters:
 - ◆ wifi_mode: WiFi protocols
 - ◇ 11BG

- ◇ 11B
- ◇ 11G
- ◇ 11BGN
- ◇ 11N
- ◆ ssid: SSID when module works as AP;
- ◆ channel: WIFI channel selection
 - ◇ AUTO
 - ◇ CH1~CH11

This Instruction only effective for USR-WIFI232-D2 works as AP. After USR-WIFI232-D2 module boots up again, the setting will be effective. But user can set this command when module configured as STA.

5.2.2.2.15 AT+WAKEY

- Function: Set/Query WIFI security parameters as AP;
- Format:
 - ◆ Query Operation

AT+WAKEY<CR>

+ok=<auth,encry,key><CR>< LF ><CR>< LF >

- ◆ Set Operation

AT+ WAKEY=< auth,encry,key><CR>

+ok<CR>< LF ><CR>< LF >

- Parameters:
 - ◆ auth: Authentication mode
 - ◇ OPEN
 - ◇ SHARED
 - ◇ WPAPSK
 - ◇ WPA2PSK
 - ◆ encry:Encryption algorithm
 - ◇ NONE: When “auth=OPEN”, effective;
 - ◇ WEP: When “auth=OPEN”, effective or “SHARED”, effective;
 - ◇ TKIP: When “auth=WPAPSK”, effective or “WPA2PSK”, effective;
 - ◇ AES:When “auth=WPAPSK”, effective or “WPA2PSK”, effective;
 - ◇ TKIPAES:When “auth=WPAPSK”, effective or “WPA2PSK”, effective;
 - ◆ key: password, ASCII code, shall less than 64 bit and greater than 8bit;

This Instruction only effective for USR-WIFI232-D2 works as AP. After USR-WIFI232-D2 module boots up again, the setting will be effective. But user can set this command when module configured as STA.

5.2.2.2.16 AT+HIDESSID

- Function: Set/Query hide AP's SSID;
- Format:
 - ◆ Query Operation

AT+HIDSSID<CR>

+ok=<sta.><CR><LF><CR><LF>

- ◆ Set Operation

AT+HIDSSID=<sta><CR>

+ok<CR><LF><CR><LF>

- Parameters:
 - ◆ When Query,sta reply if module's SSID is hide;
 - ◇ On-not hide SSID
 - ◇ Off- hide SSID
 - ◆ When Set,
 - ◇ Off-hide SSID
 - ◇ On- not hide SSID

5.2.2.2.17 AT+MSLP

- Function: Set modules into power save mode.(Turn OFF WiFi,Regardless of the AP mode or the sta mode).
- Format:
 - ◆ Query Operation

AT+ MSLP <CR>

+ok=<sta.><CR>< LF ><CR>< LF >

- ◆ Set Operation

AT+ MSLP=<on/off><CR>

+ok<CR>< LF ><CR>< LF >

- Parameters:
 - ◆ When Query,sta reply if the module in sleep mode;
 - ◇ On - Module not in sleep mode (WiFi ON);
 - ◇ Off - Module in sleep mode(WiFi OFF);
 - ◆ When Set,
 - ◇ Off - Set module to sleep mode (WiFi OFF);
 - ◇ On - Set module to normal mode (WiFi ON);

When module go into sleep mode, user can input "AT+MSLP=on" to re-start the module and module go into transparent transmission mode.

5.2.2.2.18 AT+WSCAN

- Function: Seek AP.
- Format:

AT+ WSCAN<CR>

+ok=<ap_site><CR>< LF ><CR>< LF >

- Parameters:
 - ◆ ap_site: AP searched;

The first line of the return value is "RSSI, SSID, BSSID, Channel, Encryption,Authentication", they are the signal strength, network name, MAC address,channel, mode of authentication, encryption algorithm.

5.2.2.2.19 AT+ TCPLK

- Function: Query if TCP link already build-up;
- Format:

AT+ TCPLK<CR>

+ok=<sta><CR>< LF ><CR>< LF >

- Parameters:

- ◆ sta.: if module already setup TCP link;
 - ◇ on: TCP link setup;
 - ◇ off: TCP link not setup;

5.2.2.2.20 AT + TCPDIS

- Function: Open/Close TCP (Only TCP Client available);
- Format:

- ◆ Query Operation

AT+TCPDIS<CR>

+ok=<sta><CR>< LF ><CR>< LF >

- ◆ Set Operation

AT+ TCPDIS=<on/off><CR>

+ok<CR>< LF ><CR>< LF >

- Parameters:
 - ◆ sta.: set/query TCP link status;
 - ◇ on: TCP link available; When setting “on”, module will connect to TCP server right away.
 - ◇ off: TCP link not available; when setting “off”, module will disconnect with TCP server and not connect again.

5.2.2.2.21 AT+ WANN

- Function: Set/Query WAN setting, only effective as STA mode;
- Format:

- ◆ Query Operation

AT+WANN<CR>

+ok=<mode,address,mask,gateway><CR>< LF ><CR>< LF >

- ◆ Set Operation

AT+ WANN=< mode,address,mask,gateway ><CR>

+ok<CR>< LF ><CR>< LF >

- Parameters:
 - ◆ mode: IP setting for WAN port
 - ◇ static: Static IP
 - ◇ DHCP: Dynamic IP
 - ◆ address: WAN port IP address;
 - ◆ mask: WAN port subnet mask;
 - ◆ gateway: WAN port gateway address;

This Instruction only effective for USR-WIFI232-D2 works as STA. After USR-WIFI232-D2 module boots up again, the setting will be effective. But user can set this command when module configured as AP.

5.2.2.2.22 AT+ LANN

- Function: Set/Query LAN setting, only effective as AP mode;
- Format:

- ◆ Query Operation

AT+LANN<CR>

+ok=<address,mask ><CR>< LF ><CR>< LF >

- ◆ Set Operation

AT+ LANN=<address,mask ><CR>**+ok<CR>< LF ><CR>< LF >**

- Parameters:
 - ◆ address: LAN port IP address;
 - ◆ mask: LAN port subnet mask;

This Instruction only effective for USR-WIFI232-D2 works as AP. After USR-WIFI232-D2 module boots up again, the setting will be effective. But user can set this command when module configured as STA.

Note: AT+WANN check the wan port address of module, AT+LANN check the LAN port address of module, and the two IP cannot be set on the same network segment,If do,Module will be abnormal.

5.2.2.2.23 AT+DHCPDEN

- Function: Enable/Disable LAN DHCP server function;
- Format:
 - ◆ Query Operation

AT+DHCPDEN<CR>**+ok=<sta><CR><LF><CR><LF>**

- ◆ Set Operation

AT+DHCPDEN=<sta><CR>**+ok<CR><LF><CR><LF>**

- Parameters:
 - ◆ sta. If Enable/Disable LAN DHCP server function;
 - ◇ on: Enable LAN DHCP function
 - ◇ off: Disable LAN DHCP function

5.2.2.2.24 AT+DHCPGW

- Function: Set/Query DHCP gateway address;
- Format:
 - ◆ Query Operation

AT+DHCPGW<CR>**+ok=<address><CR>< LF ><CR>< LF >**

- ◆ Set Operation

AT+DHCPGW=<address ><CR>**+ok<CR>< LF ><CR>< LF >**

- Parameters:
 - ◆ address: DHCP gate address;

5.2.2.2.25 AT+TCPTO

- Function: Set/Query TCP timeout;
- Format:
 - ◆ Query Operation

AT+TCPTO<CR>**+ok=<time><CR>< LF ><CR>< LF >**

- ◆ Set Operation

AT+TCPTO=<time ><CR>**+ok<CR>< LF ><CR>< LF >**

- Parameters:

- ◆ time: TCP timeout time.
 - ◇ ≤ 600, (600s);
 - ◇ ≥ 0, (0 means no timeout);
 - ◇ Default, 0s;

TCP timeout: module began to count when TCP channel did not receive any data, receive data purge count. If the timing time exceed TCPTO, disconnect the TCP channel. If module work in TCP Client, it will take the initiative to rewireing the TCP Server, If module work in the TCP Server, the TCP Client need active reconnection.

5.2.2.2.26 AT+MAXSK

- Function: Set/Query maxima TCP connection;
- Format:

- ◆ Query Operation

AT+MAXSK<CR>

+ok=<num><CR><LF><CR><LF>

- ◆ Set Operation

AT+MAXSK=<num><CR>

+ok<CR><LF><CR><LF>

- Parameters:
 - ◆ num: 1~32, default 32. maxima TCP connection;

When configure as TCP/Server, USR-WIFI232-D2 support maxima 32 TCP connections. If not require so much connection, user can resetting this parameters.

5.2.2.2.27 AT+TCPB

- Function: Open/Close TCPB function;
- Format:

- ◆ Query Operation

AT+TCPB<CR>

+ok=<sta><CR><LF><CR><LF>

- ◆ Set Operation

AT+TCPB=<on/off><CR>

+ok<CR><LF><CR><LF>

- Parameters:
 - ◆ sta: TCPB enable status
 - ◇ on, TCPB enable
 - ◇ off, TCPB disable

After USR-WIFI232-D2 module boots up again, the setting will be effective.

5.2.2.2.28 AT+TCPPTB

- Function: Set/Query TCPB port number;
- Format:

- ◆ Query Operation

AT+TCPPTB<CR>

+ok=<port><CR><LF><CR><LF>

- ◆ Set Operation

AT+ TCPB=<port><CR>**+ok<CR>< LF ><CR>< LF >**

- Parameters:
 - ◆ port: decimal ,<65535

After USR-WIFI232-D2 module boots up again, the setting will be effective.

5.2.2.2.29 AT+TCPADDB

- Function: Set/Query TCPB server address;
- Format:
 - ◆ Query Operation

AT+TCPADDB<CR>**+ok=<add><CR>< LF ><CR>< LF >**

- ◆ Set Operation

AT+ TCPADDB=<add><CR>**+ok<CR>< LF ><CR>< LF >**

- Parameters:
 - ◆ add: TCPB server address, can be IP address or url.

After USR-WIFI232-D2 module boots up again, the setting will be effective

5.2.2.2.30 AT+TCPTOB

- Function: Set/Query TCPB time out time;
- Format:
 - ◆ Query Operation

AT+TCPTOB<CR>**+ok=<time><CR>< LF ><CR>< LF >**

- ◆ Set Operation

AT+ TCPTOB=<time><CR>**+ok<CR>< LF ><CR>< LF >**

- Parameters:
 - ◆ time: TCPB time out time, <=600 (600s), >=0 (No time out), default 0

After USR-WIFI232-D2 module boots up again, the setting will be effective.

5.2.2.2.31 AT+TCPLKB

- Function: Query TCPB link status;
- Format:

AT+TCPCKB<CR>**+ok=<sta><CR>< LF ><CR>< LF >**

- Parameters:
 - ◆ sta: TCPB link status
 - ◇ on, TCPB link OK
 - ◇ off, TCPB link not available

5.2.2.2.32 AT+STTC

- Function: Enable/Disable STA port scan function
- Format:
 - ◆ Query Operation

AT+STTC<CR>

+ok=<sta><CR>< LF ><CR>< LF >

- ◆ Set Operation

AT+STTC=<on/off><CR>

+ok<CR><LF><CR><LF>

- Parameters:
 - ◆ Sta: when query, this value feedback
 - ◇ On: Enable STA port scan function
 - ◇ Off: Disable STA port scan function

5.2.2.2.33 AT+DOMAIN

- Function: Set/Query domain of module webpage;

- Format

- ◆ Query Operation

AT+DOMAIN<CR>

+ok=<domian><CR><LF><CR><LF>

- ◆ Set Operation

AT+DOMAIN=<domain><CR>

+ok<CR><LF><CR><LF>

- Parameters:
 - ◇ domain: domain to access to module webpage

5.2.2.2.34 AT+FUDLX

- Function: Enable/Disable 485 function;

- Format:

- ◆ Query Operation

AT+FUDLX<CR>

+ok=<on/off><CR><LF><CR><LF>

- ◆ Set Operation

AT+FUDLX=<on/off><CR>

+ok<CR><LF><CR><LF>

- Parameters:
 - ◆ On/off: Enable or Disable 485 function
 - ◇ On, enable 485 function;
 - ◇ Off, disable 485 function;

Notes: AT+FUDLX is F-Setting, means restore to factory setting will not affect this command.

5.2.2.2.35 AT+MMID

- Function: Set/Query Device ID;

- Format:

- ◆ Query Operation

AT+MMID<CR>

+ok=<time><CR>< LF ><CR>< LF >

- ◆ Set Operation

AT+ MMID=<time><CR>

+ok<CR>< LF ><CR>< LF >

- Parameters:
 - ◆ ID: device id(0~65535)

After USR-WIFI232-D2 module boots up again, the setting will be effective.

5.2.2.2.36 AT+IDFIR

- Function: Enable/Disable "Send an ID when module connection is established" function;
- Format:

- ◆ Query Operation

AT+IDFIR<CR>

+ok=<on/off><CR><LF><CR><LF>

- ◆ Set Operation

AT+IDFIR=<on/off><CR>

+ok<CR><LF><CR><LF>

- Parameters:
 - ◆ On/off: Enable or Disable "Send an ID when module connection is established" function
 - ◇ On, enable "Send an ID when module connection is established" function;
 - ◇ Off, disable "Send an ID when module connection is established" function;

5.2.2.2.37 AT+IDEVE

- Function: Enable/Disable Every time to send data to send ID function;
- Format:

- ◆ Query Operation

AT+IDEVE<CR>

+ok=<on/off><CR><LF><CR><LF>

- ◆ Set Operation

AT+IDEVE=<on/off><CR>

+ok<CR><LF><CR><LF>

- Parameters:
 - ◆ On/off: Enable or Disable Every time to send data to send ID function
 - ◇ On, enable Every time to send data to send ID function;
 - ◇ Off, disable Every time to send data to send ID function;

Note: The ID function requires that the server carries out corresponding processing. In front of the data when module connected to the server with two bytes of ID (ID the range is 0 ~ 65535, the high byte before, and the low byte behind) plus two bytes ID radix-minus-one complement. Module is the default ID is 1111, for example, is sent to the server when the first four bytes "0x57 0x04 0xfb 0xa8".

5.2.2.2.38 AT+AABR

- Function: Enable/Disable Self-adaption Baudrate function;
- Format:

- ◆ Query Operation

AT+AABR<CR>

+ok=<on/off><CR><LF><CR><LF>

- ◆ Set Operation

AT+AABR=<on/off><CR>

+ok<CR><LF><CR><LF>

- Parameters:
 - ◆ On/off: Enable or Disable 485 function
 - ◇ On, enable 485 function;
 - ◇ Off, disable 485 function;

5.2.2.2.39 AT+RELD

- Function: Restore to factory default setting;
- Format:

AT+RELD<CR>

+ok=rebooting...<CR><LF><CR><LF>

This command restores the module to factory default setting, and then re-starts the module.

5.2.2.2.40 AT+Z

- Function: Re-start module;
- Format:

AT+Z<CR>

5.2.2.2.41 AT+MID

- Function: Query module ID information;
- Format:
 - ◆ Query Operation

AT+MID<CR>

+ok=<module_id><CR><LF><CR><LF>

- Parameters:
 - ◆ module_id: MID information;
 - ◇ A11-yymmddnnnn “yymmdd” date; “nnnn” serial number;

5.2.2.2.42 AT+VER

- Function: Query module software version information;
- Format:
 - ◆ Query Operation

AT+VER<CR>

+ok=<ver><CR><LF><CR><LF>

- Parameters:
 - ◆ ver: Module software version information;

5.2.2.2.43 AT+H

- Function: Help;
- Format:
 - ◆ Query Operation

AT+H<CR>

+ok=<command help><CR><LF><CR><LF>

- Parameters:
 - ◆ command help: command introduction;

5.2.2.2.44 AT+HTTPURL

- Function: Set /Query HTTP server IP address and Port Number.
- Format:
 - ◆ Query Operation:

AT+HTTPURL<CR>

+ok=<IP,Port><CR>< LF ><CR>< LF >

◆ Set Operation:

AT+HTTPURL=<IP,Port><CR>

+ok<CR>< LF ><CR>< LF >

■ Parameters:

◆ IP:HTTP server IP address.

◆ Port:HTTP server Port number.

5.2.2.2.45 **AT+ HTTPTP**

■ Function:Set /Query HTTP request type.

■ Format:

◆ Query Operation:

AT+HTTPTP<CR>

+ok=<Type><CR>< LF ><CR>< LF >

◆ Set Operation:

AT+HTTPTP=<Type><CR>

+ok<CR>< LF ><CR>< LF >

■ Parameters:

◆ Type: GET(default) or POST.

5.2.2.2.46 **AT+ HTTPPH**

■ Function:Set/Query HTTP protocol header path.

■ Format:

◆ Query Operation:

AT+HTTPPH<CR>

+ok=<Path><CR>< LF ><CR>< LF >

◆ Set Operation:

AT+HTTPPH=<Path><CR>

+ok<CR>< LF ><CR>< LF >

■ Parameters:

◆ Path: Max length is 50 bytes.

5.2.2.2.47 **AT+ HTTPCN**

■ Function:Set/Query Connection of HTTP protocol header.

■ Format:

◆ Query Operation:

AT+HTTPCN<CR>

+ok=<Connection><CR>< LF ><CR>< LF >

◆ Set Operation:

AT+HTTPCN=<Connection><CR>

+ok<CR>< LF ><CR>< LF >

■ Parameters:

◆ Connection: Max length is 20 bytes.

5.2.2.2.48 **AT+ HTTPUA**

■ Function:Set/Query User-Agent of HTTP protocol header.

■ Format:

◆ Query Operation:

AT+HTTPIUA<CR>**+ok=<Parameter><CR>< LF ><CR>< LF >**

◆ Set Operation:

AT+HTTPIUA=<Parameter><CR>**+ok<CR>< LF ><CR>< LF >**

■ Parameters:

◆ Parameter: Max length is 20 bytes.

5.2.2.2.49 AT+EPHYA

■ Function: Open/Close ETH1 interface;

■ Format:

◆ Set Operation

AT+ EPHYA=<on/off><CR>**+ok<CR>< LF ><CR>< LF >**

■ Parameters:

◆ On/off

✧ Off: Close Ethernet port1 function;

✧ On: Open Ethernet port1 function;

5.2.2.2.50 AT+EPHYB

■ Function: Open/Close ETH2 interface;

■ Format:

◆ Set Operation

AT+ EPHYB=<on/off><CR>**+ok<CR>< LF ><CR>< LF >**

■ Parameters:

◆ On/off

✧ Off: Close Ethernet port2 function;

✧ On: Open Ethernet port2 function;

Use AT + FVEW = disable/enable, so you can set the modules work in LAN port (disable) or wan port (enable), the directive restore factory Settings to take effect.

5.2.2.2.51 AT+WSSSIDA

■ Function: Set/query the first AP's ssid of 3 sta parameters settings .

■ Format:

◆ Query Operation

AT+WSSSIDA<CR>**+ok=<ap's ssid><CR>< LF ><CR>< LF >**

◆ Set Operation

AT+ WSSSIDA=<ap's ssid ><CR>**+ok<CR>< LF ><CR>< LF >**

■ Parameters:

◆ ap's ssid: AP's SSID

This Instruction only effective for USR-WIFI232-A/B/C works as STA. After USR-WIFI232-A/B/C module boots up again, the setting will be effective. But user can set this command when module configured as AP.

5.2.2.2.52 AT+WSSSIDB

- Function: Set/query the second AP's ssid of 3 sta parameters settings .
- Format:

- ◆ Query Operation

AT+WSSSIDB<CR>

+ok=<ap's ssid><CR>< LF ><CR>< LF >

- ◆ Set Operation

AT+ WSSSIDB=<ap's ssid ><CR>

+ok<CR>< LF ><CR>< LF >

- Parameters:
 - ◆ ap's ssid: AP's SSID

This Instruction only effective for USR-WIFI232-A/B/C works as STA. After USR-WIFI232-A/B/C module boots up again, the setting will be effective. But user can set this command when module configured as AP.

5.2.2.2.53 AT+WSSSIDC

- Function: Set/query the third AP's ssid of 3 sta parameters settings .
- Format:

- ◆ Query Operation

AT+WSSSIDC<CR>

+ok=<ap's ssid><CR>< LF ><CR>< LF >

- ◆ Set Operation

AT+ WSSSIDC=<ap's ssid ><CR>

+ok<CR>< LF ><CR>< LF >

- Parameters:
 - ◆ ap's ssid: AP's SSID

This Instruction only effective for USR-WIFI232-A/B/C works as STA. After USR-WIFI232-A/B/C module boots up again, the setting will be effective. But user can set this command when module configured as AP.

5.2.2.2.54 AT+WSKEYA

- Function: Set/query the first AP's password of 3 sta parameters settings .
- Format:

- ◆ Query Operation

AT+WSKEYA<CR>

+ok=<auth,encry,key><CR>< LF ><CR>< LF >

- ◆ Set Operation

AT+ WSKEYA=< auth,encry,key><CR>

+ok<CR>< LF ><CR>< LF >

- Parameters:
 - ◆ auth: Authentication mode
 - ◇ OPEN
 - ◇ SHARED
 - ◇ WPAPSK
 - ◇ WPA2PSK
 - ◆ encry:Encryption algorithm
 - ◇ NONE: When "auth=OPEN", effective

- ✧ WEP: When "auth=OPEN" or "SHARED", effective
- ✧ TKIP: When "auth= WPAPSK", effective or "WPA2PSK", effective
- ✧ AES: When "auth= WPAPSK", effective or "WPA2PSK", effective
- ◆ key: password, ASCII code, shall less than 64 bit and greater than 8bit

This Instruction only effective for USR-WIFI232-A/B/C works as STA. After USR-WIFI232-A/B/C module boots up again, the setting will be effective. But user can set this command when module configured as AP.

5.2.2.2.55 AT+WSKEYB

- Function: Set/query the second AP's password of 3 sta parameters settings .
- Format:
 - ◆ Query Operation

AT+WSKEYB<CR>

+ok=<auth,encry,key><CR>< LF ><CR>< LF >

- ◆ Set Operation

AT+ WSKEYB=< auth,encry,key><CR>

+ok<CR>< LF ><CR>< LF >

- Parameters:
 - ◆ auth: Authentication mode
 - ✧ OPEN
 - ✧ SHARED
 - ✧ WPAPSK
 - ✧ WPA2PSK
 - ◆ encry:Encryption algorithm
 - ✧ NONE: When "auth=OPEN", effective
 - ✧ WEP: When "auth=OPEN" or "SHARED", effective
 - ✧ TKIP: When "auth= WPAPSK", effective or "WPA2PSK", effective
 - ✧ AES: When "auth= WPAPSK", effective or "WPA2PSK", effective
 - ◆ key: password, ASCII code, shall less than 64 bit and greater than 8bit

This Instruction only effective for USR-WIFI232-A/B/C works as STA. After USR-WIFI232-A/B/C module boots up again, the setting will be effective. But user can set this command when module configured as AP.

5.2.2.2.56 AT+WSKEYC

- Function: Set/query the third AP's password of 3 sta parameters settings .
- Format:
 - ◆ Query Operation

AT+WSKEYC<CR>

+ok=<auth,encry,key><CR>< LF ><CR>< LF >

- ◆ Set Operation

AT+ WSKEYC=< auth,encry,key><CR>

+ok<CR>< LF ><CR>< LF >

- Parameters:
 - ◆ auth: Authentication mode

- ✧ OPEN
- ✧ SHARED
- ✧ WPAPSK
- ✧ WPA2PSK
- ◆ encry:Encryption algorithm
 - ✧ NONE: When “auth=OPEN”, effective
 - ✧ WEP: When “auth=OPEN” or “SHARED”, effective
 - ✧ TKIP: When “auth= WPAPSK”, effective or “WPA2PSK”, effective
 - ✧ AES: When “auth= WPAPSK”, effective or “WPA2PSK”, effective
- ◆ key: password, ASCII code, shall less than 64 bit and greater than 8bit

This Instruction only effective for USR-WIFI232-A/B/C works as STA. After USR-WIFI232-A/B/C module boots up again, the setting will be effective. But user can set this command when module configured as AP.

5.2.2.2.57 AT+ WSQY

- Function: Set/query the critiacl value of network switching.
- Format:
 - ◆ Query Operation

AT+ WSQY<CR>

+ok=<ret><CR>< LF ><CR>< LF >

- ◆ Set Operation

AT+ WSQY< auth,encry,key><CR>

+ok<CR>< LF ><CR>< LF >

- Parameters:
 - ◆ ret:The percentage of signal intensity, such as signalstrength was 50%, setting should be AT+WSQY=50<CR>;

Note: if set to 100, the module will not automatically switch WIFI network.If the users only one STA parameter, please be sure to set this parameter to 100.

5.2.2.2.58 AT+ HTPMODE

- Function: The switch of new/old HTTP headers setting mode(HTTPD Client).
- Format:
 - ◆ Query Operation

AT+ HTPMODE<CR>

+ok=<type><CR>< LF ><CR>< LF >

- ◆ Set Operation

AT+ HTPMODE=< type><CR>

+ok<CR>< LF ><CR>< LF >

- Parameters:
 - ◆ type:
 - ✧ new: The new HTTP headers setting mode.
 - ✧ old:The old HTTP headers setting mode.

5.2.2.2.59 AT+ HTPSV

- Function:Set /Query HTTP server IP address and Port Number.
- Format:
 - ◆ Query Operation:

AT+HTPSV<CR>

+ok=<IP,Port><CR>< LF ><CR>< LF >

◆ Set Operation:

AT+HTPSV=<IP,Port><CR>

+ok<CR>< LF ><CR>< LF >

■ Parameters:

◆ IP:HTTP server IP address.

◆ Port:HTTP server Port number。

5.2.2.2.60 **AT+ HTPTP**

■ Function:Set /Query HTTP request type.

■ Format:

◆ Query Operation:

AT+HTPTP<CR>

+ok=<Type><CR>< LF ><CR>< LF >

◆ Set Operation:

AT+HTPTP=<Type><CR>

+ok<CR>< LF ><CR>< LF >

■ Parameters:

◆ Type: GET(default) or POST.

5.2.2.2.61 **AT+ HTPURL**

■ Function:Set/Query HTTP header path.

■ Format:

◆ Query Operation:

AT+HTPURL<CR>

+ok=<Path><CR>< LF ><CR>< LF >

◆ Set Operation:

AT+HTPURL=<Path><CR>

+ok<CR>< LF ><CR>< LF >

■ Parameters:

◆ Path: Max length is 50 bytes.

5.2.2.2.62 **AT+ HTPHEAD**

■ Function:Set/Query HTTP header.

■ Format:

◆ Query Operation:

AT+HTPHEAD<CR>

+ok=<head><CR>< LF ><CR>< LF >

◆ Set Operation:

AT+HTPHEAD=<head><CR>

+ok<CR>< LF ><CR>< LF >

■ Parameters:

◆ head: HTTP header,Please use the "<<CRLF>>" instead of carriage "return",Max length:200 bytes.

Note: the AT command of AT + HTPMODE, AT + HTPSV, AT + HTPTP, AT + HTPURL,AT + HTPHEAD is supported in V5.01D.14 and above version.

5.2.2.2.63 AT+ REGEN

- Function: Settings/query Registered Package Type.
- Format:
 - ◆ Query Operation

AT+ REGEN<CR>

+ok=<mode><CR>< LF ><CR>< LF >

- ◆ Set Operation

AT+ REGEN=<mode><CR>

+ok<CR>< LF ><CR>< LF >

- Parameters:
 - ◆ mode:
 - ◇ id: Registered package of ID.
 - ◇ mac:Registered package of MAC.
 - ◇ off: disable Registered package

5.2.2.2.64 AT+ REGTCP

- Function: Settings/query Upload Manner.
- Format:
 - ◆ Query Operation

AT+ REGTCP<CR>

+ok=<type><CR>< LF ><CR>< LF >

- ◆ Set Operation

AT+ REGTCP=<type><CR>

+ok<CR>< LF ><CR>< LF >

- Parameters:
 - ◆ type:
 - ◇ first: Module send registration packet when connection established.
 - ◇ every:Send registration packet every time when module send data.

5.2.2.2.65 AT+ REGID

- Function: Settings/query Device ID.
- Format:
 - ◆ Query Operation

AT+ REGID<CR>

+ok=<ID><CR>< LF ><CR>< LF >

- ◆ Set Operation

AT+ REGID=<ID><CR>

+ok<CR>< LF ><CR>< LF >

- Parameters:
 - ◆ ID:ID number, the range is 0 to 65535

Note: the AT command of AT + REDEN, AT + REGTCP, AT + REGID is supported in V5.01D.14 and above version.

5.2.2.2.66 AT+IPBUP

- Function: Open/Close domain IP backup function;
- Format:
 - ◆ Query Operation

AT+IPBUP<CR>**+ok=<backup-a,backup-b><CR>< LF ><CR>< LF >**

- ◆ Set Operation

AT+ IPBUP=<backup-a,backup-b><CR>**+ok<CR>< LF ><CR>< LF >**

- Parameters:
 - ◆ sta: TCPB enable status
 - ◇ on, enable TCPA domain IP backup
 - ◇ off, disable TCPA domain IP backup
 - ◆ sta: TCPB enable status
 - ◇ on, enable TCPB domain IP backup
 - ◇ off, disable TCPB domain IP backup

It is off by default.

5.2.2.2.67 AT+ STAPRO

- Function: Settings/query Smart Station.
- Format:
 - ◆ Query Operation

AT+ STAPRO<CR>**+ok=<mode><CR>< LF ><CR>< LF >**

- ◆ Set Operation

AT+ STAPRO=<mode><CR>**+ok<CR>< LF ><CR>< LF >**

- Parameters:
 - ◆ mode:
 - ◇ on: enable Smart station.
 - ◇ off:disable Smart station

It is off by default.

6 USR-WIFI232-D2 Usage Introduction

6.1 Module Debug

6.1.1 Software Debug Tools

In order to facilitate the use of my company, development of the serial and network debugging two-in-one test software, USR-TCP232-Test



USR-TCP232-Test.exe

6.1.2 Network Connection

In order to test the serial port to the WIFI network address conversion, we will module serial connected with the computer, network and computer links to WIFI.

Due to the need to have both a WIFI and serial special requirements, only a minority of the notebook computer can achieve, the user can use the desktop with a USB card, or use the notebook computer with a USB to serial line way, the author uses the desktop and WIFI card form test, desktop with serial. (Note: there USB transfer RS232 the line quality uneven, some good and some bad, in order not to waste your valuable time, look for buying a used FT232 chip scheme suggested switching line, about the price \$10)

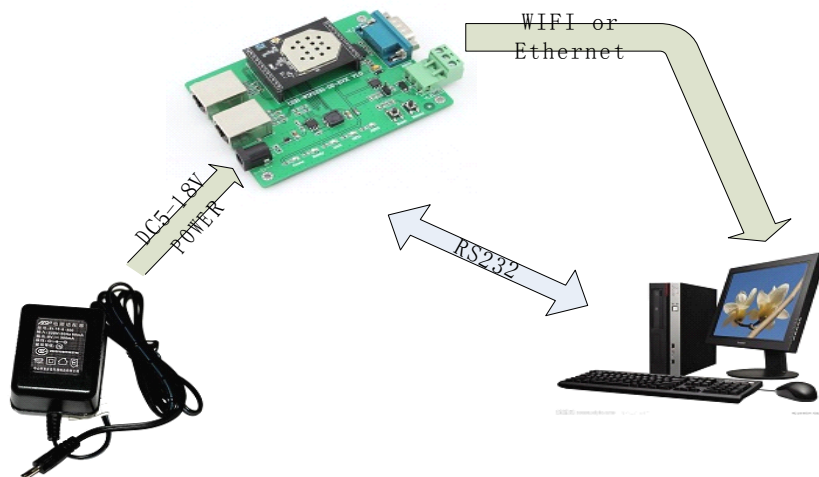

Figure 46 **Connection diagram**

On the serial connection, module pin leads to 3.3V TTL level, not directly connected with the computer, need to bring the bottom or users are TTL to RS232 connecting line connected to the computer, in order to facilitate the user to test the use of, we provide a variety of floor for the user to choose, here in the case of USR-WIFI232-2.

Hardware connectivity, for module power supply, the red power indicator light, wait about 6 seconds (internal system boot), Ready lights, said system startup complete, can operate, entering the next step.

6.1.3 Debug

As shown above, opened in PC program, set the COM export and open the serial port connection

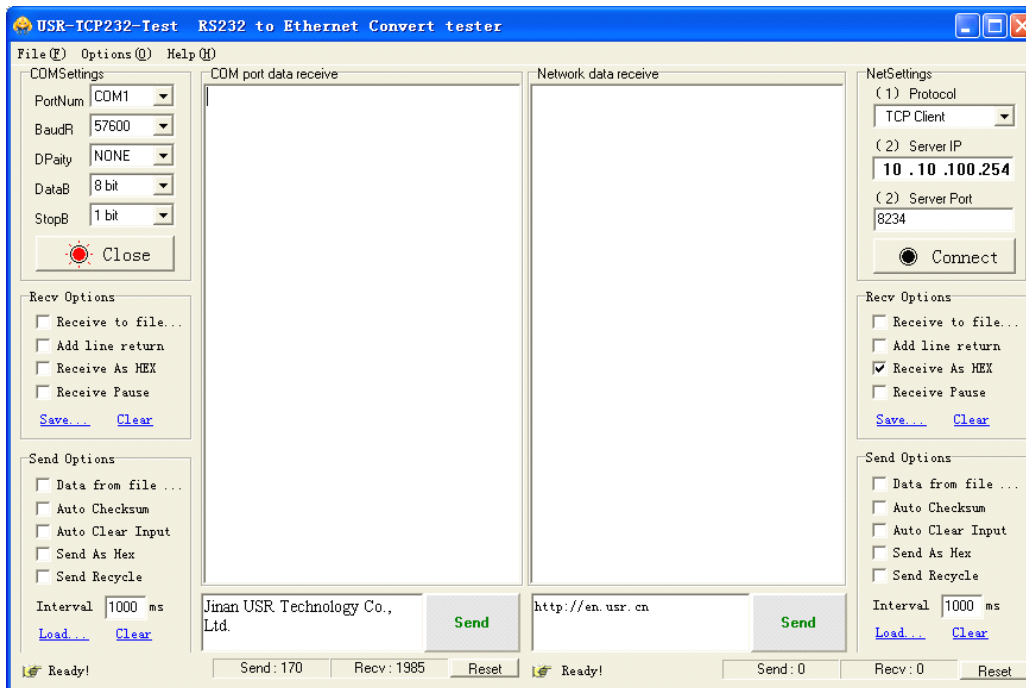

Figure 47 **“CommTools” Serial Debug Tools**

Open test software USR-TCP232-Test.exe, selection of hardware attached to the computer's serial number, this is COM1, choose 57600 baud rate, such as the WIFI module serial default baud rate, open the serial port.

Network settings in TCP client mode, the server IP address input 10.10.100.254, this is WIFI module default IP address, server port number 8899, this module default monitor TCP port number, click the link to establish TCP connection, Then click the create connection.

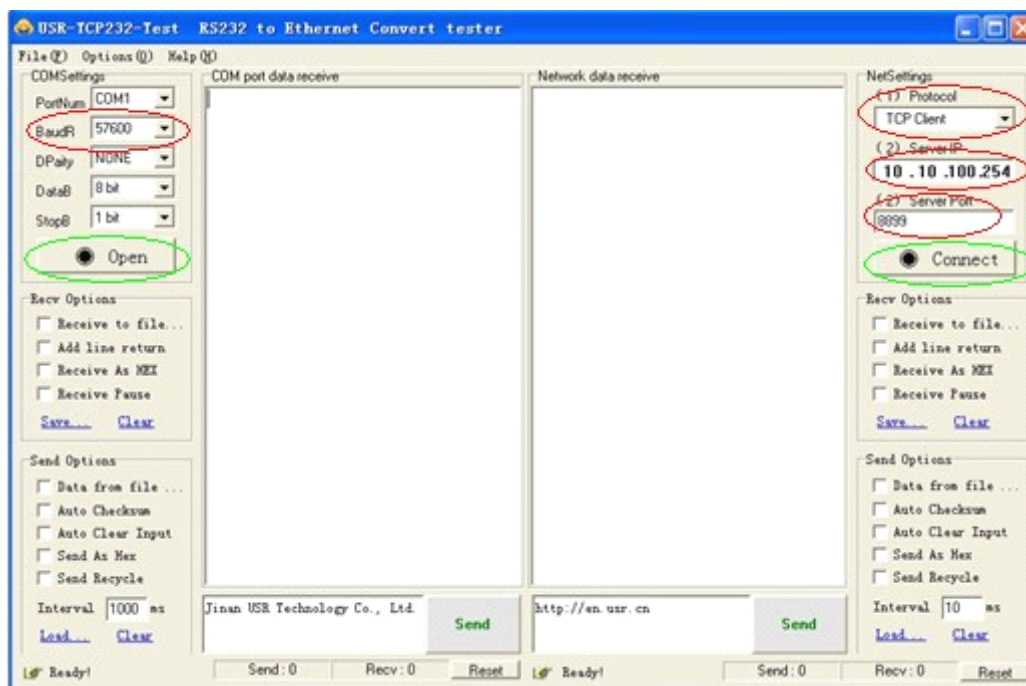

Figure 48 **“TCP UDPDbg” Tools Create Connection**

Because of the USR-WIFI232-D2 module default support for transparent transmission mode, so now you can debug tools two-way data, all data will be wholly intact transmission to the other side of display. The testing process can be seen in module TXD and RXD indicator lights in the data through the flashing.

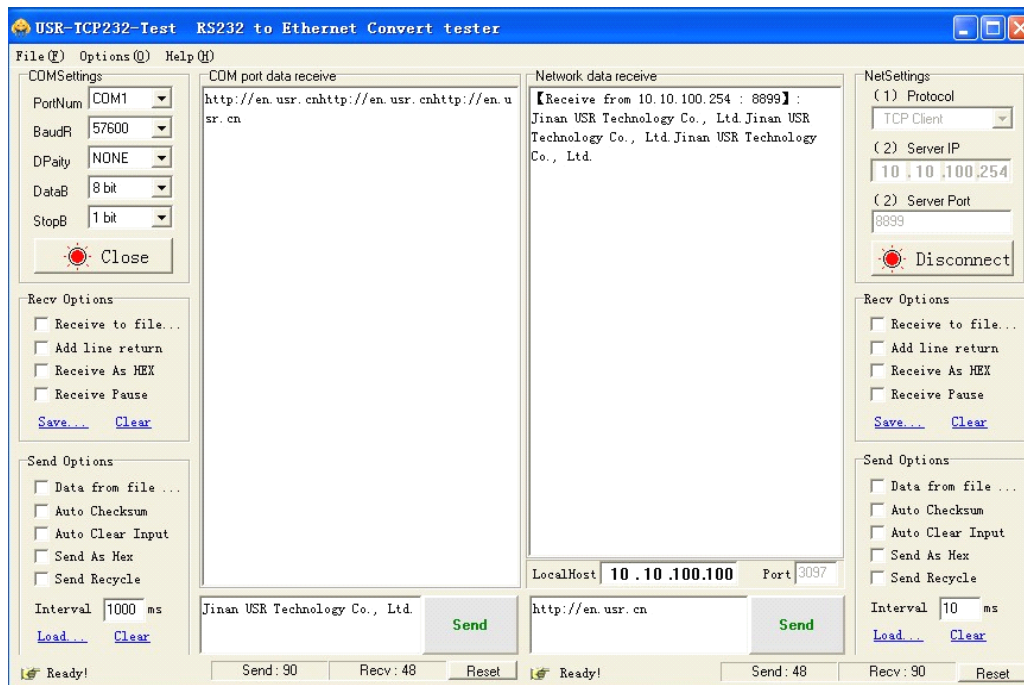

Figure 49 **The test results show that the network and serial port**

Note: because of the RTS/CTS pin processing difference, currently available on the part of the serial debugging software for the module of the system is not available, please be sure to want to use USR-TCP232-Test we provide testing, or just RXD TXD GND connected the three line to the computer, please notice.

6.2 Use Cases

6.2.1 Wireless Control Application

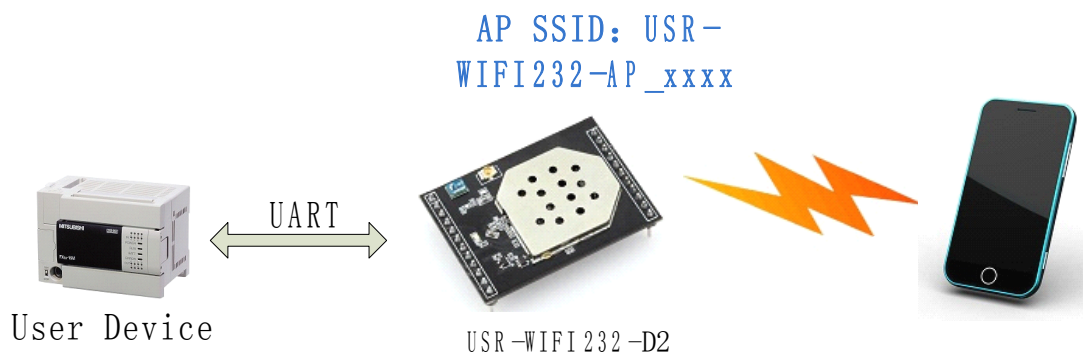

Figure 50 **Wireless Control Application**

For this wireless control application, USR-WIFI232-D2 works as AP mode. Module's serial port connects to user device. So, control agent (Smart phone for this example) can manage and control the user device through the wireless connection with USR-WIFI232-D2 module.

6.2.2 Remote Management Application

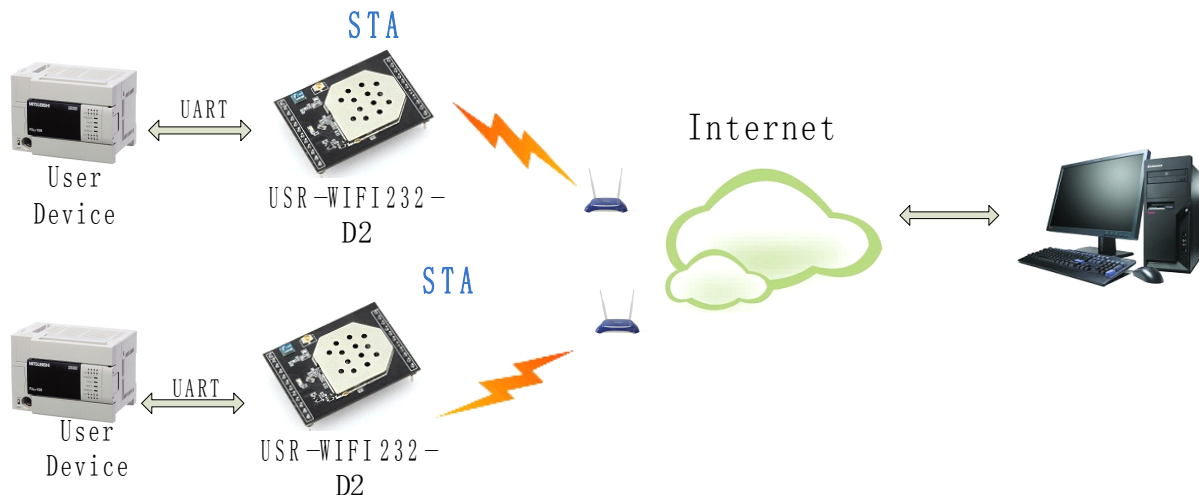

Figure 51 Remote Management Application

For this remote management application, USR-WIFI232-D2 works as STA mode and connects to Internet through wireless AP. Module configured as TCP Client and communicates with remote TCP server at Internet. Module's serial port connects to user device.

So, user device's data or sampling information can send to remote TCP server for storage or processing. Also remote TCP server can send command to control and manage the user device through the wireless network.

6.2.3 Transparent Serial Port Application

For this transparent serial port application, two USR-WIFI232-D2 modules connect as below figures to build up a transparent serial port connection.

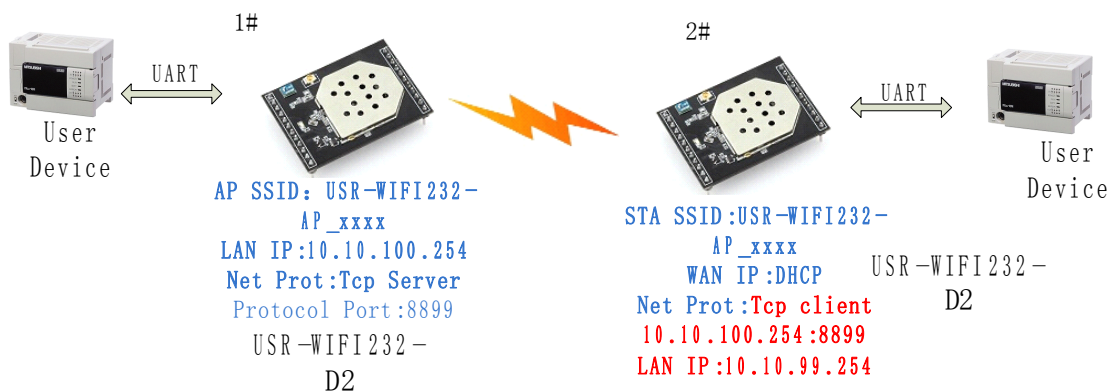

Figure 52 Transparent Serial Port Application

For left side USR-WIFI232-D2 module, configured as AP mode and use default SSID and IP address, network protocol configured as TCP/Server mode, and protocol port ID: 8899.

For right side USR-WIFI232-D2 module, configured as STA mode and setting the same SSID (“USR-WIFI232-D2_xxxx” for this example) with left side USR-WIFI232-D2 module, enable DHCP network and network protocol configured as TCP/Client mode, protocol port ID: 8899. Target IP address part setting the same IP address with left side USR-WIFI232-D2 module (“10.10.100.254” for this example).

When right side USR-WIFI232-D2 boot up, it will find wireless AP (SSID: USR-WIFI232-D2_xxxx for this example) and open TCP/Client network protocol to connect with left side module’s TCP/Server. All these operation will be automatic and after finished, the two user devices connected to USR-WIFI232-D2 module through serial port can communicate each other and think the connection between them is fully transparent.

Note: LAN IP address and WAN port should in different segment, as picture shown, we change to 10.10.99.254 (the address get from left module WAN port DHCP is 10.10.100.xxx)

6.2.4 Wireless Data Acquisition Card Application

For this wireless data acquisition card application, one PC works as data server and every data acquisition card connects with a USR-WIFI232-D2 module to support wireless connection function.

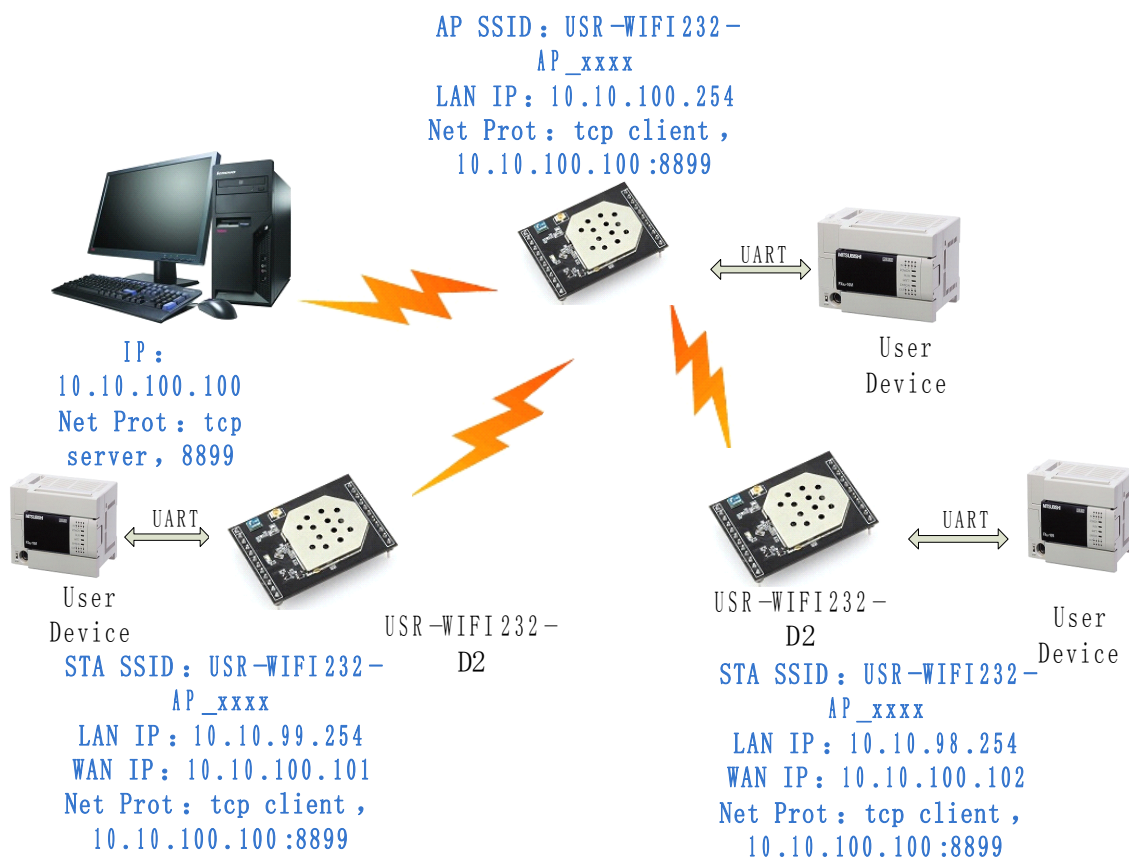

Figure 53 Wireless Data Acquisition Card Application

As above figure, one USR-WIFI232-D2 configured as AP mode and all others configured as STA mode. All USR-WIFI232-D2 which configured as STA and data server PC wireless connected to USR-WIFI232-D2 which configured as AP to make up a wireless network.

Data server PC open TCP/Server protocol and all USR-WIFI232-D2 modules open TCP/Client protocol. All data acquisition cards' data and sampling information can be transmitted to data server PC for operation.

Appendix A: Questions and Answers

Q1: How to configure transparent serial port application (TCP protocol) with two wifi modules?

➤ Network structure as below figure:

■ Module 1# Setting:

- ◇ Works as AP mode; --See "Mode Selection Page"
- ◇ LAN IP address: 10.10.100.254; --See "AP Interface Setting Page"
- ◇ Network Protocol:TCP/Server, Port ID: 8899; -- See "Application Setting Page"
(Module default setting);

■ Module 2# Setting:

- ◇ Works as STA mode; --See "Mode Selection Page"
- ◇ WAN connection type: DHCP or Static IP (For this example:10.10.100.100) --See "STA Interface Setting Page"
- ◇ Network Protocol:TCP/Client, Port ID: 8899; Application IP address: Module 1#'s LAN IP address (10.10.100.254); -- See "Application Setting Page"
- ◇ **Notes:** When module 2# works as STA mode, module's WiFi interface works as WAN port. Module's WAN IP address and LAN IP address shall be setting different segment. So, module 2#'s LAN IP address must change to other segment; (For this sample, we change to 10.10.99.254); --See "AP Interface Setting Page"

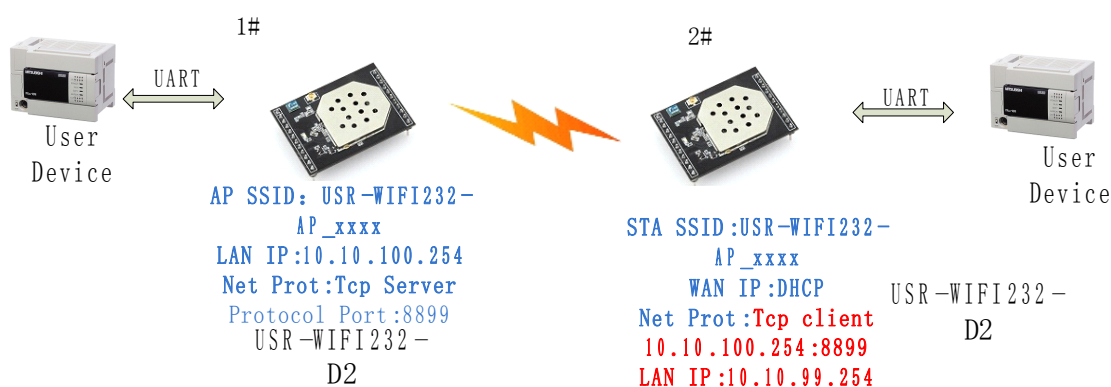

Figure 54 **Configure Transparent Serial Port Connection (TCP)**

Q2: Where to Set WIFI Module LAN IP and WAN IP through Web Page?

- USR-WIFI232-D2 Wireless LAN IP address setting see “AP Interface Setting Page” as below Figure,

LAN Setup	
IP Address	10.10.100.254
Subnet Mask	255.255.255.0
MAC Address	88:8B:5D:70:04:87
DHCP Type	Server
Default DHCP Gateway	10.10.100.254

Figure 55 **Module LAN IP Setting**

- USR-WIFI232-D2 Wireless WAN IP address setting see “STA Interface Setting Page” as below Figure, User can set WAN connection type to DHCP and STATIC IP.

WAN Connection Type:

Static Mode	
IP Address	10.10.99.254
Subnet Mask	255.255.0.0
Default Gateway	10.10.99.254

Figure 56 **Module WAN IP Setting**

Q3: How to configure transparent serial port application (UDP protocol) with two wifi modules?

- Network structure as below figure:
 - Module 1# Setting:
 - ✧ Works as AP mode; *--See “Mode Selection Page”*
 - ✧ LAN IP address: 10.10.100.254; *--See “AP Interface Setting Page”*
 - ✧ Network Protocol:UDP, Port ID: 8899; Application IP address:10.10.100.100; *-- See “Application Setting Page”*
 - Module 2# Setting:
 - ✧ Works as STA mode; *--See “Mode Selection Page”*
 - ✧ WAN connection type: Static IP (10.10.100.100) *--See “STA Interface Setting Page”*
 - ✧ Network Protocol:UDP, Port ID: 8899; Application IP address: Module 1#'s LAN IP address (10.10.100.254); *-- See “Application Setting Page”*
 - ✧ LAN IP address: 10.10.99.254 (Different net segment with WAN port)

--See "AP Interface Setting Page"

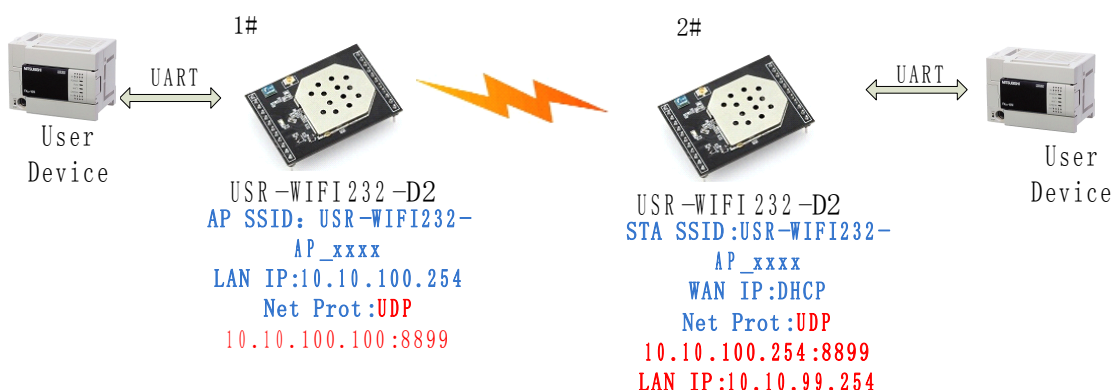

Figure 57 **Configure Transparent Serial Port Connection (UDP)**

Q4: Where to set USR-WIFI232-D2 module network protocol (TCP/UDP)?

- USR-WIFI232-D2 network protocol setting see "Application Setting Page" as below Figure,
 - Protocol: TCP Server
 - ✧ Only Port ID required: 8899 (Default)

Net Setting	
Mode	Server
Protocol	TCP
Port	8899
IP Address	10.10.10.100
TCP Time out (MAX 600 s)	300

Figure 58 **Module Network Protocols: TCP/Server**

- Protocol: TCP Client
 - ✧ Application IP address required: it's target TCP server 's IP address;
 - ✧ Port ID required: 8899 (Default)

Net Setting	
Mode	Client
Protocol	TCP
Port	8899
IP Address	10.10.10.100
TCP Time out (MAX 600 s)	300

Figure 59 **Module Network Protocol: TCP/Client**

- Protocol: UDP
 - ✧ No Server/Client selection required;

- ✧ Application IP address required: it's target device 's IP address;
- ✧ Port ID required: 8899 (Default)

Net Setting	
Mode	Client
Protocol	UDP
Port	8899
IP Address	10.10.10.100

Figure 60 **Module Network Protocol: UDP**

Q5: How to configure transparent serial port application: Two WIFI modules all configured as STA and connection through AP?

- Network structure as below figure:
 - Module 1# Setting: (We use USR-WIFI232-D2 as AP for this example)
 - ✧ Works as AP mode and all default setting;
 - Module 2# Setting:
 - ✧ Works as STA mode; --See "Mode Selection Page"
 - ✧ WAN connection type: Static IP: 10.10.100.100; --See "STA Interface Setting Page"
 - ✧ Network Protocol:TCP/Server, Port ID: 8899; -- See "Application Setting Page"
 - ✧ LAN IP address: 10.10.99.254 (Different net segment with WAN port); --See "AP Interface Setting Page"
 - Module 3# Setting:
 - ✧ Works as STA mode; --See "Mode Selection Page"
 - ✧ WAN connection type: Static IP: 10.10.100.101; --See "STA Interface Setting Page"
 - ✧ Network Protocol:TCP/Client, Port ID: 8899; Application IP address: Module 2#'s WAN IP address (10.10.100.100); -- See "Application Setting Page"
 - ✧ LAN IP address: 10.10.98.254 (Different net segment with WAN port); --See "AP Interface Setting Page"

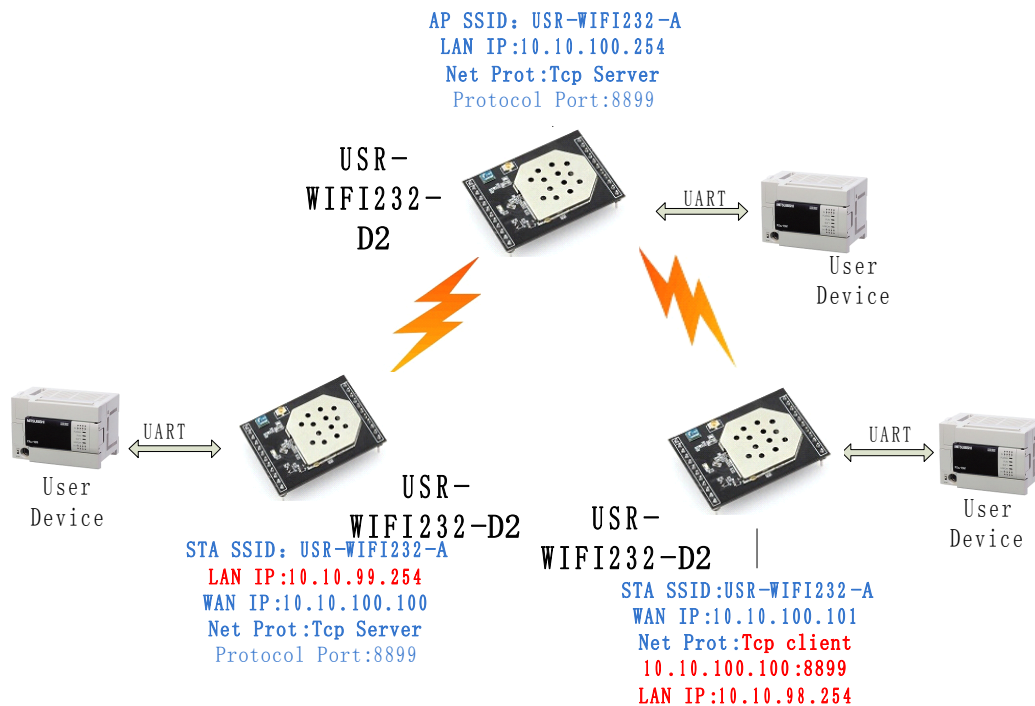

Figure 61 Two USR-WIFI232-D2 Modules Connection Through AP

Q6: How to avoid IP address conflict when apply USR-WIFI232-D2 module?

- The following address allocation method can avoid the IP address conflict for dynamic and static IP address mixed application.
 - Module dynamic IP address range from 100 to 200 for last IP address segment.
 - ✧ Such as default IP: 10.10.100.254. When module works as AP, the IP address module can allocate to STA is from 10.10.100.100 to 10.10.100.200;
 - So, if user needs to set static IP for dedicated STA internal network, the available IP address range can start from 10.10.100.1 to 10.10.100.99.

Q7: PC works as server, all WIFI modules works as data acquisition card and connect with PC, how to configure this application?

- Network structure as below figure: Three USR-WIFI232-D2 module setup 3 TCP links with PC server. Module 1# works as AP and all devices connect to module 1# through WiFi interface;
 - PC Setting:
 - ✧ IP address: 10.10.100.100;
 - ✧ Network Protocol:TCP/Server, Port ID: 8899;
 - Module 1# Setting:
 - ✧ Works as AP mode;

- ✧ LAN IP address: 10.10.100.254;
- ✧ Network Protocol:TCP/Client, Port ID: 8899; Application IP address:10.10.100.100;
- **Module 2# Setting:**
 - ✧ Works as STA mode;
 - ✧ WAN connection type: Static IP: 10.10.100.101;
 - ✧ Network Protocol:TCP/Client, Port ID: 8899; Application IP address:10.10.100.100;
 - ✧ LAN IP address: 10.10.99.254 (Different net segment with WAN port);
- **Module 3# Setting:**
 - ✧ Works as STA mode;
 - ✧ WAN connection type: Static IP: 10.10.100.102;
 - ✧ Network Protocol:TCP/Client, Port ID: 8899; Application IP address:10.10.100.100;
 - ✧ LAN IP address: 10.10.98.254 (Different net segment with WAN port);

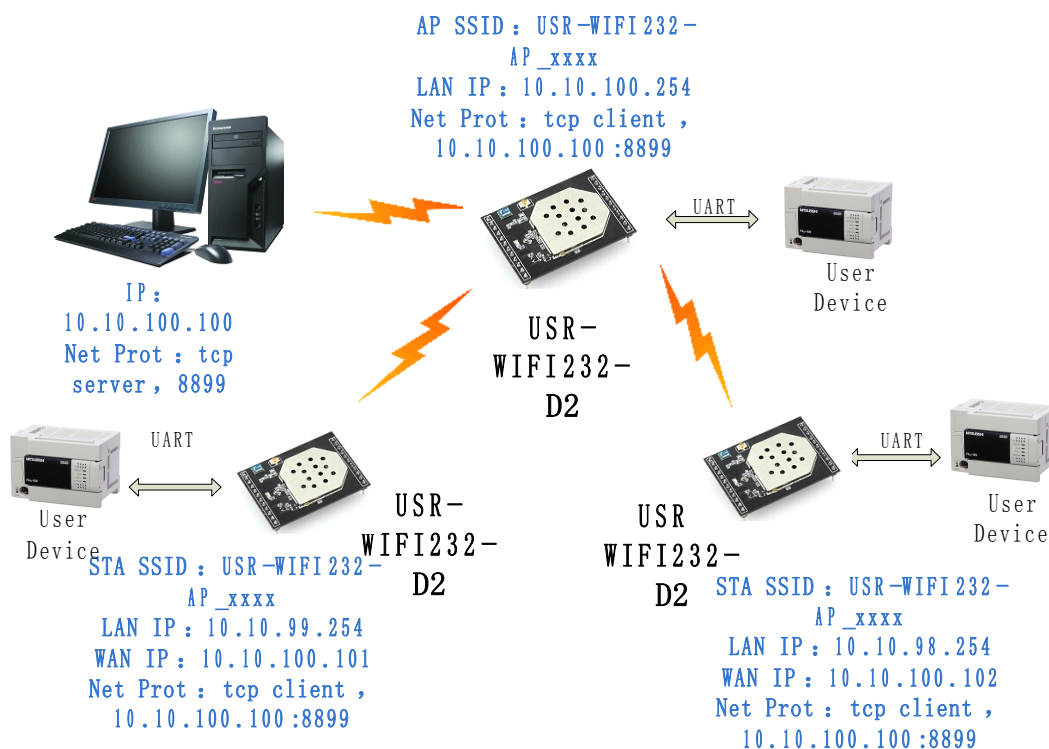

Figure 62 **Wireless Data Acquisition Card Setting**

Q8: WIFI module support UDP multicast?

At present, all the WIFI module does not support UDP multicast function,IP multicast address range is "224.0.0.0~ 239.255.255.255",When setting module, please don't set this IP section, if set, may cause the module can't normal start.

Q9:WIFI module operates in STA mode, the PC how to get the IP module?

All wifi module supports UDP search,they will return to their respective IP, MAC, MID, detailed search process is as follows:

1. PC via UDP broadcast (broadcast address: xx.xx.xx.255, Port: 48899) sent a password, the default password is: "HF-A11ASSISTHREAD", the password can be used AT commands (AT + FASWD) set up,it's Up to 100 bytes.
2. After the module receives a password, if the password is correct, to the address (Unicast, Port: 48899) sends local IP address and MAC address and name of the module. (IP, MAC, MID as 10.10.100.254,888 B5D0000E2, guxin).

So you can get to the IP address of the module.

Appendix b: evb reference design

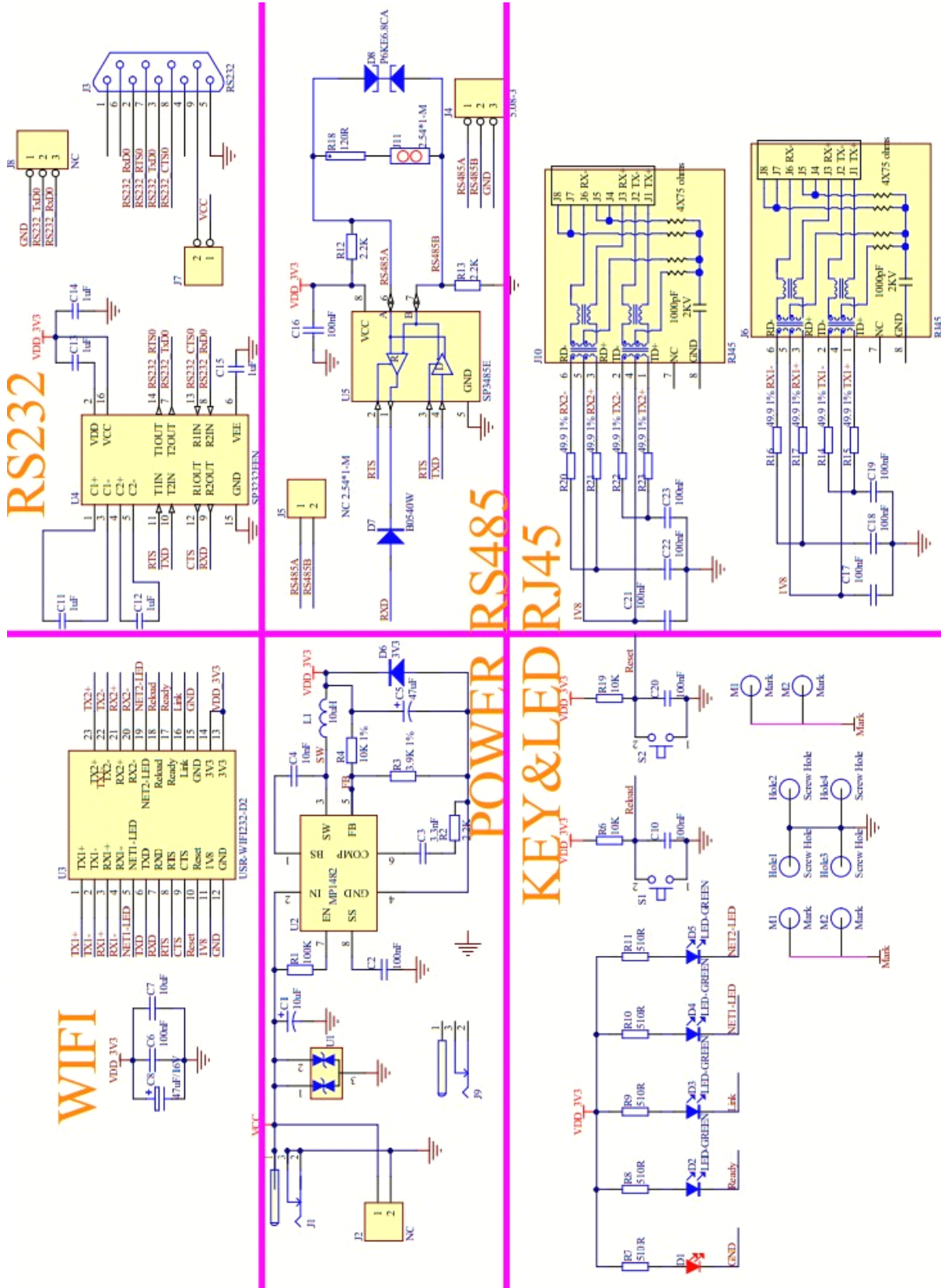

Appendix c: external power shutdown mode reference design

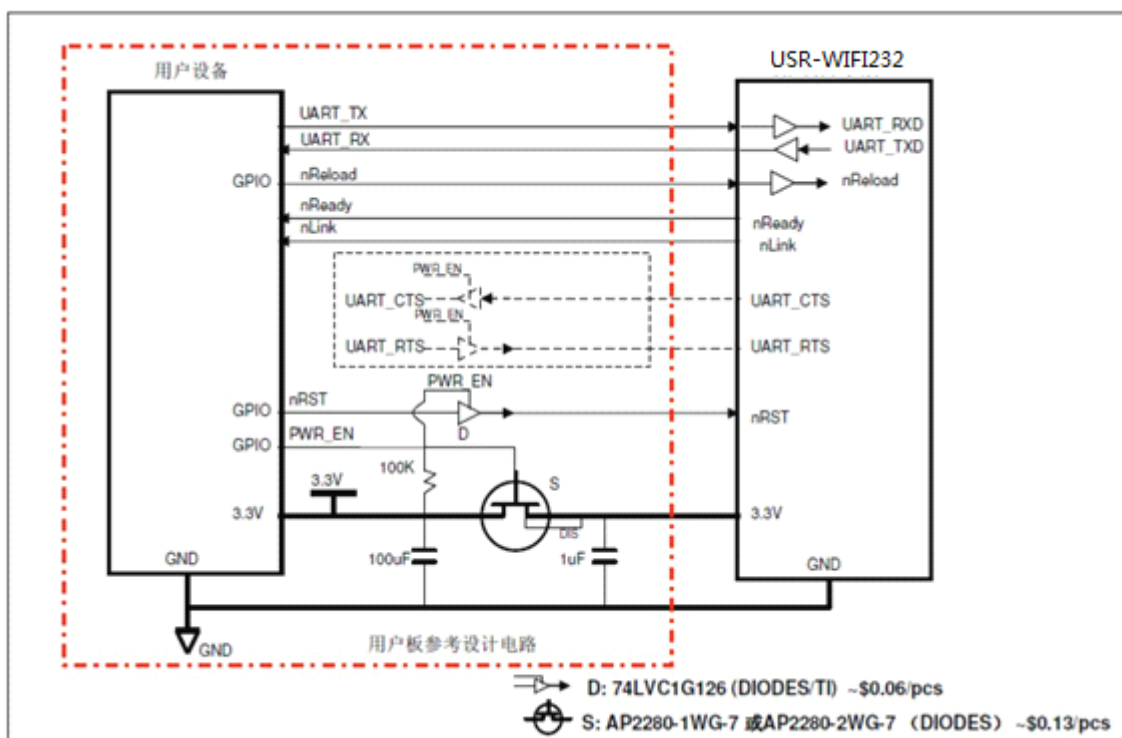

Appendix e: Contact Information

Contact us:

Company: Jinan USR IOT Technology Limited
Address: 11th Floor, No.1 Building, Aosheng Square, No.1166 Xinluo Street, Jinan, China
Tel: 86-531-55507297, 86-531-88826739
Web: <http://www.usriot.com>
Support: <http://h.usriot.com>
Email: sales@usr.cn

Appendix f: Disclaimer

This document provides information about USR-WIFI232-D2 modules, this document does not grant any license to intellectual property rights. Except the responsibility declared in the product sale clause, USR does not assume any other responsibilities. In addition, USR does not make any warranties for the sale and use of this product, including the suitability of the product for a particular purpose, merchantability or fitness for any patent, copyright or other intellectual property infringement, etc. USR may make changes to specifications and product descriptions without notice.

Appendix g: History

Ed.V1.0.0 Created on 7-11-2014.

Ed.V1.0.1 Created on 10-20-2014

Add uslink function agreement.

Modify the AT + TMODE parameters

Ed.V1.0.2 Created on 11-12-2014

Modify the problem of TCPB in the specification,The AT command related is AT+TCPB/AT+TCPPTB etc.

Modify Self-adaption Baudrate function,default open.

Delete the AT + FRLDEN.

Ed.V1.0.3 Created on 12-22-2014

Add the AT setting of three sta parameter sets

Ed.V1.0.5 Created on 12-29-2014

More advanced Settings page, including the port mapping and DDNS

Ed.V1.0.6 Created on 01-19-2014

Modify the AT+WSQL to AT+WSQY.

Ed.V1.0.7 Update on 16-03-2015

Modify the registration packet types, increase the upload MAC function and modify the corresponding instructions (based on V5.01D.14 and above).

Modify the setting of the HTTP header, change to custom header, and compatible the old way of setting (based on V5.01D.14 and above version).

Ed.V1.0.8 Update on 28-05-2015

modify the minimum temperature - 40

Increase the tip of 80, 8000, and 49000 ports

Ed.V1.0.9 Update on 10-06-2015

Modify the description of the pin(20-23)

Ed.V1.0.10 Update on 16-06-2015

Increase customer support center link, remove WAPI encryption.

Ed.V1.0.11 Update on 29-06-2015

Increase the Modbus TCP <=> Modbus RTU function.

Increase the software flow control

Add DNS IP backup function, increase the STA model protection function

Ed.V1.0.12 Update on 20-07-2015

Amend the company address.Modify some describe errors

END OF DOCUMENT